

Overview

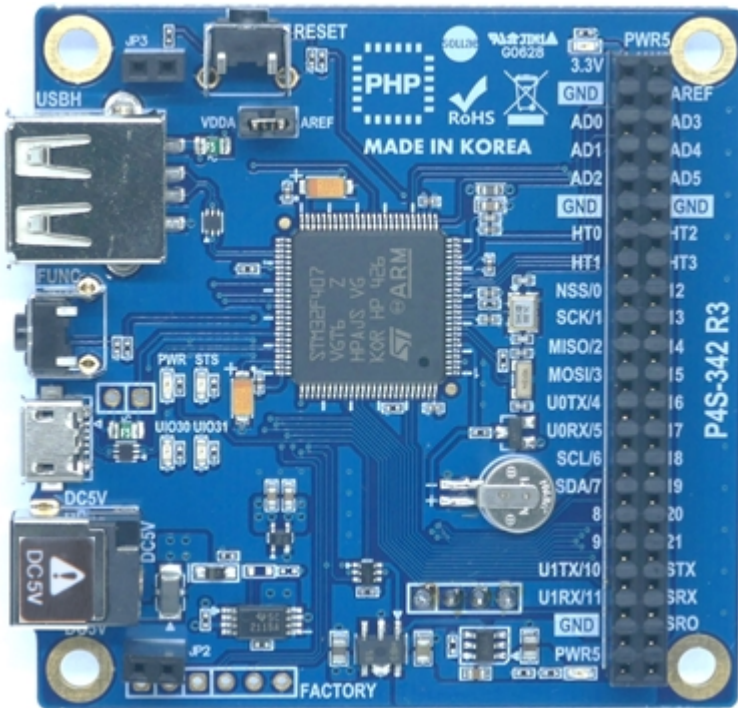

P4S-342 is an industrial programmable I/O board. You can build various network communication systems connecting P4S-342 to many devices such as sensors and actuators. We provide a self-development programming language, which is called PHPoC, for programming P4S-342. This language is easy to use and compatible with PHP which is widely used script language.

※ PHPoC is basically compatible with PHP but those languages are not the same because of restrictions about embedded system. Refer to the [PHPoC Language Reference](#) and [PHPoC vs PHP](#) for detailed information.

Features

- Provides Self-Development PHPoC Interpreter
- Provides simple development environment via USB
- Provides IEEE802.11b/g Wireless LAN
- Provides 22 digital i/o and 6 analog input ports
- Provides 2 UART ports
- Provides 4 hardware timer
- Provides I2C and SPI interfaces
- Provides PHPoC Debugger - a development tool for Windows

H/W Specification

Power	Input 1	DC 5V ($\pm 0.5V$)
	Input 2	DC 5V ($\pm 0.5V$) - USB Device Port
	Current Consumption	Typical - about 85mA(※ without USB WLAN adapter) Power Down mode - less than 200uA
Dimension		66.2mm x 63.8mm x 13mm
Weight		about 26.7g (without USB WLAN adapter)
Interface	UART	2 X UART Ports(UART0 ~ 1), Baudrate: 1,200 bps ~ 460,800 bps
	Network	IEEE802.11b/g Wireless LAN (require Ralink RT3070/5370 chipset Wireless LAN Adapter)
	USB	USB Host - for WLAN adapter USB Device - for PC
	Digital I/O	UIO0: pin #0 ~ #21, #30(LED), #31(LED)
	Analog Input	ADC_CH0 ~ 5, AREF, 12-bit resolution
	Hardware Timer (HT)	HT0 ~ 3, toggle/pulse/pwm output and capture mode
	SPI	NSS, SCK, MISO, MOSI
	I2C	SCL, SDA
Internal Battery		3V(rechargeable)
Wireless LAN Security		WPA-PSK / WPA2-PSK, WPA-Enterprise(TLS/TTLS/PEAP)
Temperature	Storage /Operating	-20°C ~ 60°C
Environment		RoHS Compliant

Dimension

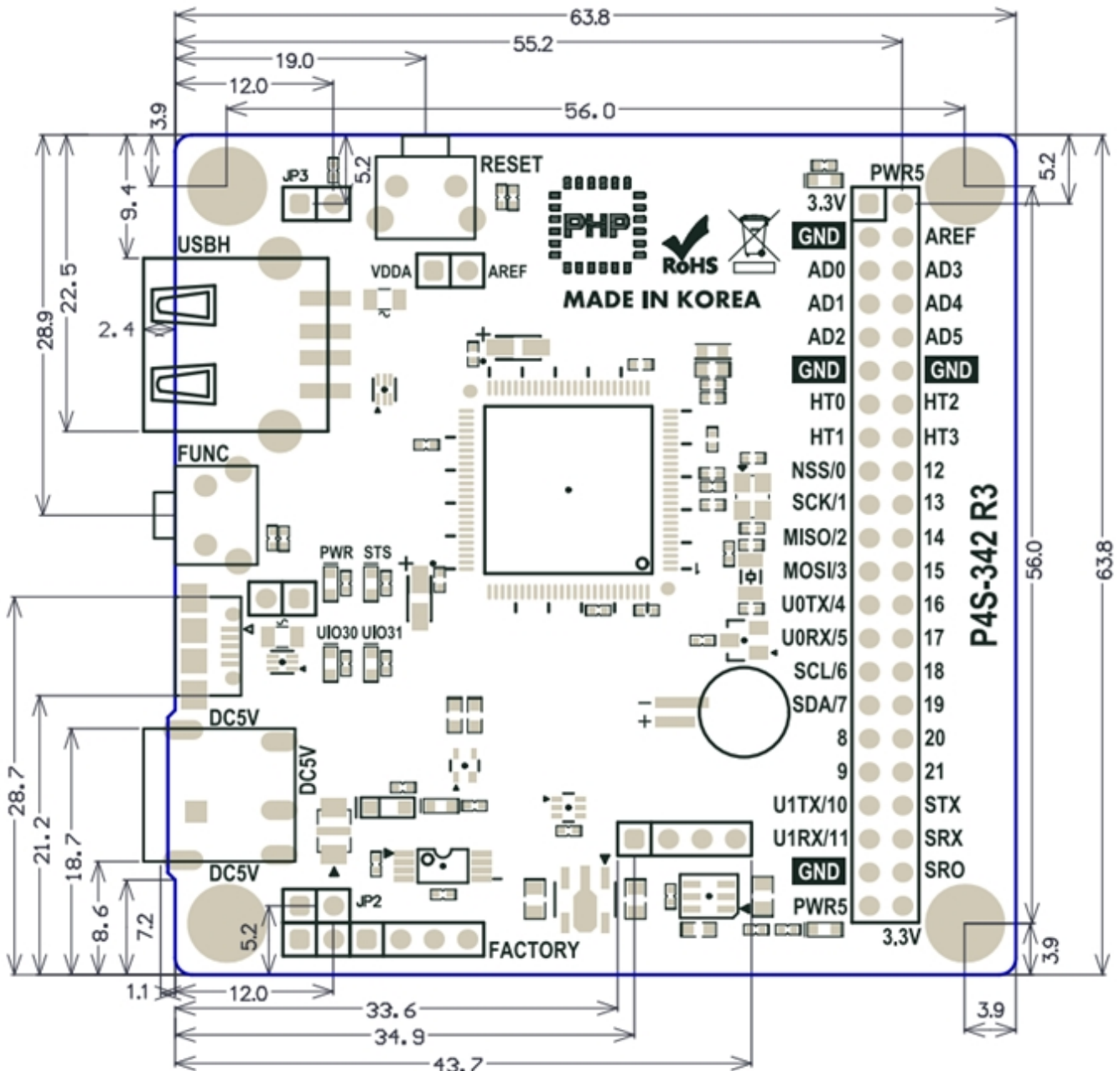

P4S-342 R3 Dimension (mm)

※ Dimensions may vary according to a method of measurement.

Layout

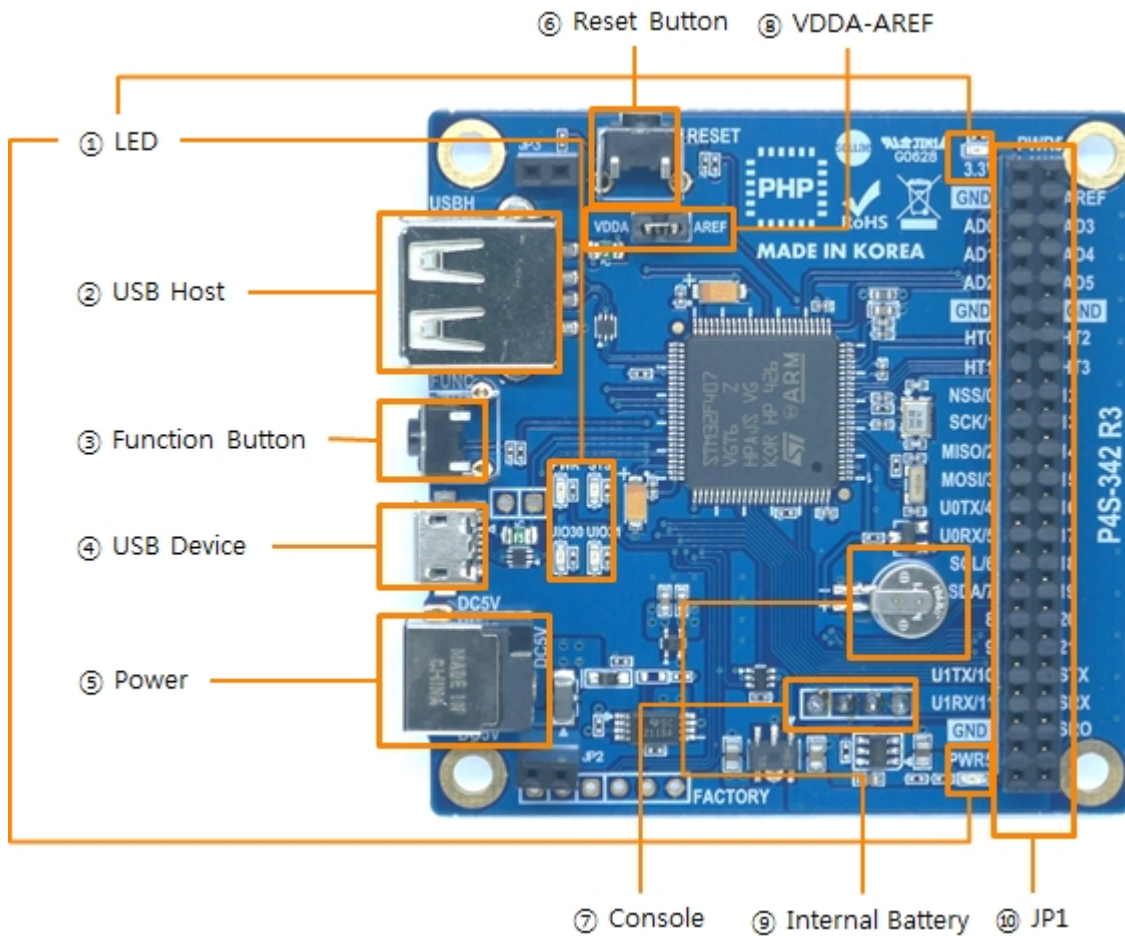

1. LED

There are six LEDs on the P4S-342 board.

LED	Action
PWR / 3.3V / PWR5	supplying power > ON
STS	running PHP > repeat On and Off in every second not running PHP > briefly blinks 1 time at a time
UIO30	on board LED: connected with 30th pin of UIO0
UIO31	on board LED: connected with 31th pin of UIO0

※ PWR, STS, UIO30 and UIO31 are also located on the opposite side.

2. USB Host Port for Connection with WLAN adapter

P4S-342 provides a USB host port for an USB WLAN adapter. You can connect P4S-342 to Wireless LAN by connecting an WLAN adapter to this port.

※ Caution: Only adapters using Ralink RT3070/5370 chipsets are available.

3. Function Button (Func)

The function button is used for changing mode to the Button setup mode.

4. USB Device Port for connection with PC

The USB device port is to connect with PC. You can access to P4S-342 via development tool by connecting USB cable to this port. You can supply DC 5V power through this port. However, P4S-342 may not work properly in case of supplying power via this port only due to insufficient current.

5. Supplying Power

- DC 5V Input

This port is the main input port for supplying power. Specification is as follows:

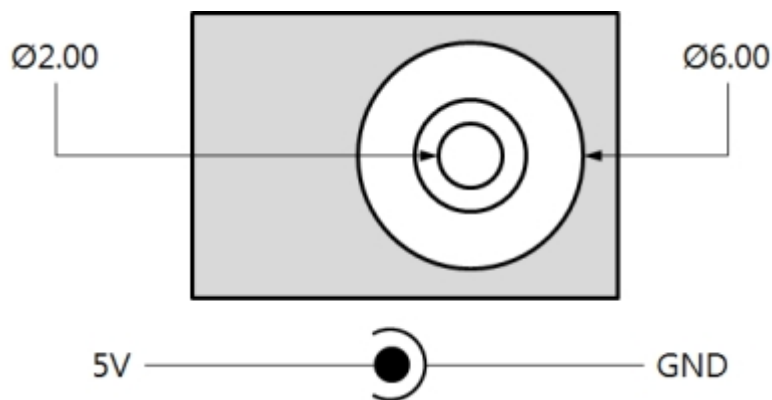

- USB Device port (Micro USB)

This port can be a sub input port for supplying power.

6. Reset Button (RESET)

This button is used for hardware reset.

7. Console Port

This port is console port for management.

Division	Value
Signal Level	3.3V
Configuration	115,200bps / 8 Data bit / 1 Stop bit / No parity
Pin Assignment	#1 - 3.3V, #2 - RX, #3 - TX, #4 - GND

8. JP1

Label	Description	Label	Description
3.3V	3.3V Output	PWR5	Output Supplied Power (5V±0.5V)
GND	Ground	AREF	ADC reference input port
AD0	ADC channel 0	AD3	ADC channel 3
AD1	ADC channel 1	AD4	ADC channel 4
AD2	ADC channel 2	AD5	ADC channel 5
GND	Ground	GND	Ground
HT0	Hardware Timer 0	HT2	Hardware Timer 2
HT1	Hardware Timer 1	HT3	Hardware Timer 3
NSS/0	SPI - NSS / UIO0 #0	12	UART #1 RTS / UIO0 #12
SCK/1	SPI - SCK / UIO0 #1	13	UART #1 CTS / UIO0 #13
MISO/2	SPI - MISO / UIO0 #2	14	UIO0 #14
MOSI/3	SPI - MOSI / UIO0 #3	15	UIO0 #15
U0TX/4	UART #0 TX / UIO0 #4	16	UIO0 #16
U0RX/5	UART #0 RX / UIO0 #5	17	UIO0 #17
SCL/6	I2C - SCL / UIO0 #6	18	UIO0 #18
SDA/7	I2C - SDA / UIO0 #7	19	UIO0 #19
8	UART#0 RTS / UIO0 #8	20	UIO0 #20
9	UART #0 CTS / UIO0 #9	21	UIO0 #21
U1TX/10	UART #1 TX/ UIO0 #10	STX	Reserved
U1RX/11	UART #1 RX/ UIO0 #11	SRX	Reserved
GND	Ground	SR0	Reserved
PWR5	Output Supplied Power (5V±0.5V)	3.3V	3.3V Output

9. VDDA-AREF

If you connect this port, 3.3V is supplied to the analog input reference port (AREF).

10. Internal Battery

Internal battery is for saving log messages and operating RTC. Specification of this battery is as follows:

Parameter	Value
Capacity	5.8mAh
Nominal Voltage	DC 3V
Charge Voltage	DC 2.8V ~ 3.1V

Communication Interface (JP1)

Analog Input: ADC

P4S-341 provides 6 ADC input channels. To use this input, it is required to connect reference voltage to an AREF pin. If you connect a VDDA-AREF jumper, 3.3V is supplied to the AREF pin.

Specification of an ADC port is as follows:

Parameter	Value
Resolution	12 bits (0 ~ 4095)
Input Type	DC Voltage (Max. 3.3V)
Number of Channel	6 channels
Interfaced Pin Label	AREF, AD0 ~ 5

Hardware Timer: HT

P4S-341 provides 4 hardware timers called HT.

Specification of HT is as follows:

Parameter	Value
Mode	Output mode(toggle, pulse, PWM), Capture mode
Unit	ms(millisecond) or us(microsecond)
Number of Channel	4 channels
Interfaced Pin Label	HT0 ~ 3

Digital Inputs/Outputs: UIO

P4S-342 provides 24 digital I/O ports including 22 universal I/O ports (numbered 0 to 21) and 2 LED ports (numbered 30 and 31). Two LEDs on board are assigned to number 30 and 31. The pins numbered 0 to 21 can be available to be set digital input or output but note that pins which are shared with serial interfaces (numbered 0 to 13) cannot be available to use a digital input or output while they are being used by the serial communication (UART, SPI and I2C).

- Electrical Characteristics of Digital I/O

Parameter	Description	Min.[V]	Max.[V]	Current
V_{IH}	HIGH level input	2.31	-	-
V_{IL}	LOW level input	0	0.99	-
V_{OH}	HIGH level output	2.4	-	+8mA
V_{OL}	LOW level output	0	0.4	+8mA

- Pin Assignment of Digital I/O

DIO LED Not Assigned

#7	#6	#5	#4	#3	#2	#1	#0
#15	#14	#13	#12	#11	#10	#9	#8
#23	#22	#21	#20	#19	#18	#17	#16
#31	#30	#29	#28	#27	#26	#25	#24

"/mmap/uio0"

Serial: UART

P4S-342 provides 2 UART ports.
Specification of UART is as follows:

Division	Value
Number of Port	2
Interfaced Pin Label	UART0: Required(U0TX/4, U0RX/5, GND), Optional(U0RTS/8, U0CTS/9) UART1: Required(U1TX/10, U1RX/11, GND), Optional(U1RTS/12, U1CTS/13)
Signal Level	3.3V
Baud Rate	1,200 ~ 460,800 [bps]
Parity	NONE / EVEN / ODD / MARK / SPACE
Data bit	8 / 7(Parity is required to use 7 data bit mode)
Stop bit	1 / 2
Flow Control	NONE, RTS/CTS

Serial: SPI

P4S-342 provides a SPI interface.
Specification of SPI is as follows:

Parameter	Value
Number of Port	1
Signal Level	3.3V
Interfaced Pin Label	NSS/0, SCLK/1, MOSI/2, MISO/3
SPI mode	mode 0 ~ 3
Bit Order	LSB > MSB or MSB > LSB
Transmission Unit	8bit or 16bit
Basic Clock Speed	42MHz
Frequency	2 / 4 / 8 / 16 / 32 / 64 / 128 / 256

Serial: I2C

P4S-342 provides an I2C interface.
Specification of I2C is as follows:

Parameter	Value
Number of Port	1
Signal level	3.3V
Interfaced Pin Label	SCL, SDA
Data Rate	Standard mode(100Kbps) or Fast mode(400Kbps)
Address Type	7bits

※ Refer to the [PHPoC Device Programming Guide for p40](#) for detailed information about interfaces.

Software (IDE)

PHPoC Debugger

PHPoC Debugger is a software used for developing and setting PHPoC products. You need to install this program on your PC for using PHPoC.

- [Download PHPoC Debugger](#)
- [PHPoC Debugger Manual](#)



Functions and Features of PHPoC Debugger

- Upload files from local PC to PHPoC
- Download files in PHPoC to local PC
- Edit files stored in PHPoC
- Debug PHPoC scripts
- Monitor resources of PHPoC
- Configure parameters PHPoC
- Upgrade Firmware of PHPoC
- Support MS Windows O/S

Connecting Product

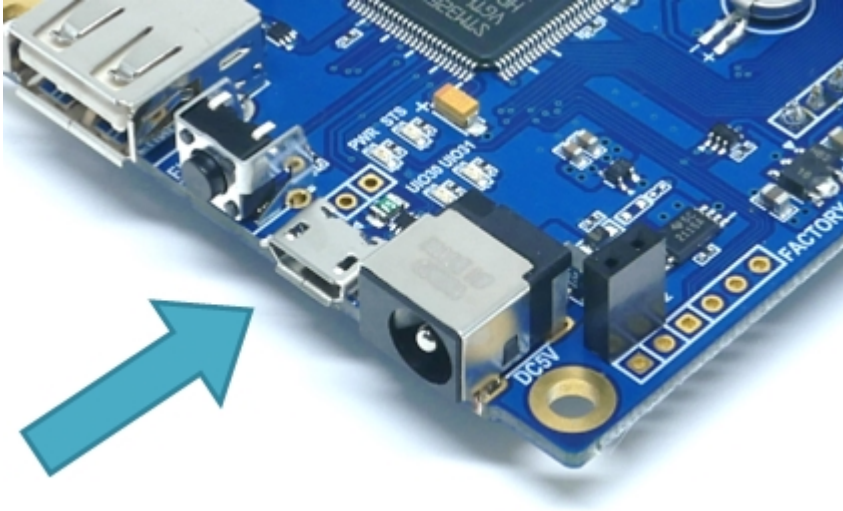
1. Connect the USB device port of P4S-342 to your PC via a USB cable.



2. Run PHPoC Debugger
3. Select connected COM PORT and press connect () button.
4. If USB is successfully connected, connect button will be inactivated and disconnect button () will be activated

Settings Reset

Settings Reset makes all settings of your PHPoC products to factory default.
A certificate in PHPoC is also deleted.

- Settings Reset Procedure

Step	Action	Product State	STS LED
1	Press function button shortly (less than 1 second)	Button setup mode	On
2	Keep pressing the function button over 5 seconds	Preparing initialization	Blink very rapidly
3	Check if the STS LED is turned OFF	Initialization ready	Off
4	Release the function button right after the STS is OFF.(※ If you don't release the button within 2 seconds, the state go back to the step 3)	Progressing initialization	On
5	Rebooting automatically	Initial state	Off

Web Interface

PHPoC itself has a webserver to provide a web interface. When receiving a HTTP request, it executes the php script in the requested file (if there) and respond to the client. Webserver is independent of PHPoC main script. TCP 80 is used for web server and you can use the interface via Internet Explorer, Chrome or any other web browsers.

How to use web interface

To use the web interface, "index.php" file should be in the file system of P4S-342. Connect to this page by entering device IP address after connecting it to network.

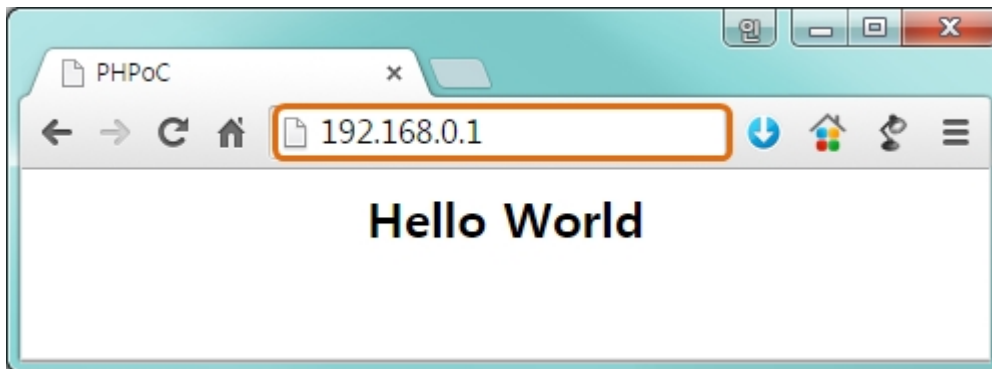

If the name of file is not "index.php", just specify the name of file after the IP address with slash mark.

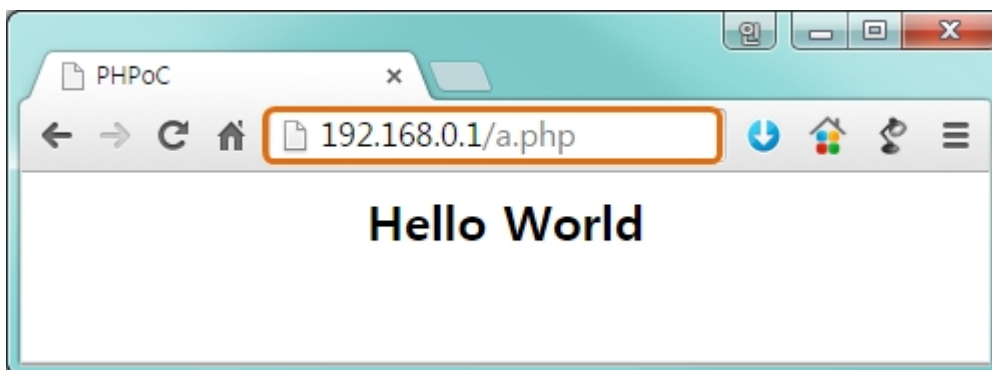

Practical Use of Web Interface

A web interface is very useful because it runs even a state which is activating [Simple WLAN Connection](#) function. If you upload web pages for specific functions, you can easily use them through wireless LAN.

Simple WLAN Connection

P4S-342 enters into Button Setup Mode when you push function button in normal state. In this mode, Simple WLAN Connection function is activated if a USB WLAN adapter is connected so you can access to P4S-342 by smartphone or laptop by WLAN.

- ※ Only the task for not basic task but [web interface](#) runs in the Button Setup Mode.
- ※ Simple WLAN Connection function is available by connecting a USB WLAN adapter.

SSID

Once WLAN Easy Connect function is activated in the Button setup mode, P4S-342 uses SSID including its own MAC address like an AP. SSID is contained the second half of the P4S-342's MAC address after "phpoc_" which is a prefix.

For example, if the MAC address is "0030f9060101", the SSID is "phpoc_060101".

WLAN Connection

Find the SSID of P4S-342 via a smartphone or laptop.



DHCP

While using WLAN Easy Connect function, a mobile automatically gets a dynamic IP address from your P4S-342. The IP address of P4S-342 is fixed to 192.168.0.1 and mobile obtains an IP address in 192.168.X.X range.

Access to Product

After uploading a setting page to P4S-342, you can access to it by web browser.

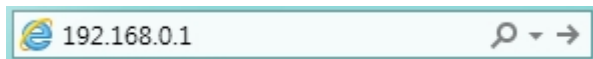

Escape Infinite Reset

PHPoC basically runs scripts when it boots up. Therefore, it is possible that a P4S-342 cannot be escaped from infinite reboot when script contains system command such as "reboot". To solve this problem, it is required to stop the running script.

Refer to the following.

1. Entering ISP mode

Make P4S-342 to enter ISP mode by supplying power while pressing FUNC button. In the ISP mode, you can access to PHPoC by PHPoC Debugger without running a script.

2. Connect to PHPoC

Connect a PC to PHPoC via a USB cable and connect to the port via PHPoC Debugger. A message window related with ISP mode will be popped up.

3. Reboot PHPoC

Reboot PHPoC by using "Reboot a product" menu in PHPoC Debugger. After rebooting, PHPoC stops running script even it is not in the ISP mode.

4. Correct source code

Correct the source code to prevent infinite reboot state.

Device Information

Device	Channel	Path	Note
UART	2	/mmap/uart0~1	-
NET	1	/mmap/net0	-
TCP	5	/mmap/tcp0~4	-
UDP	5	/mmap/udp0~4	-
Digital I/O	1	/mmap/uio0	pin #0 ~ #21, #30, #31
ADC	2	/mmap/adc0~1	-
ST	8	/mmap/st0~7	-
HT	4	/mmap/ht0~3	-
SPI	1	/mmap/spi0	-
I2C	1	/mmap/i2c0	-
RTC	1	/mmap/rtc0	-
UM	4	/mmap/um0~3	-
NM	1	/mmap/nm0	-

※ Refer to the [PHPoC Device Programming Guide for p40](#) for detailed information about using devices.