

RS422/485 - Ethernet Converter

CSE-H55N User's Manual

Version 1.5



Sollae Systems Co., Ltd.

<http://www.ezTCP.com>



This symbol, found on your product or on its packaging, indicates that this product should not be treated as household waste when you wish to dispose of it. Instead, it should be handed over to an applicable collection point for the recycling of electrical and electronic equipment. By ensuring this product is disposed of correctly, you will help prevent potential negative consequences to the environment and human health, which could otherwise be caused by inappropriate disposal of this product. The recycling of materials will help to conserve natural resources. For more detailed information about the recycling of this product, please contact your local city office, household waste disposal service or the retail store where you purchased this product.

※ This equipment obtained certification by using 1.5M serial cable.

Contents

1	Overview	- 6 -
1.1	Overview	- 6 -
1.2	Features	- 6 -
1.3	Application Examples	- 7 -
1.4	Components.....	- 9 -
1.5	Specification	- 10 -
1.5.1	<i>Hardware</i>	<i>- 10 -</i>
1.5.2	<i>Software</i>	<i>- 10 -</i>
1.6	Interfaces	- 11 -
1.6.1	<i>Serial Interface</i>	<i>- 11 -</i>
1.6.2	<i>Ethernet Interface.....</i>	<i>- 13 -</i>
1.6.3	<i>Power.....</i>	<i>- 14 -</i>
1.7	System LED	- 15 -
1.7.1	<i>Function button.....</i>	<i>- 16 -</i>
2	Installation and Test.....	- 17 -
2.1	Installation.....	- 17 -
2.1.1	<i>Setting Network Area.....</i>	<i>- 18 -</i>
2.2	Simple Test.....	- 20 -
3	Configuration	- 23 -
3.1	Configuration with ezManager.....	- 23 -
3.1.1	<i>Configuration via LAN.....</i>	<i>- 23 -</i>
3.1.2	<i>Configuration via Serial</i>	<i>- 24 -</i>
3.2	AT command.....	- 25 -
4	Operation Modes	- 26 -
4.1	What is the Operation Mode?.....	- 26 -
4.2	How to entering each mode	- 26 -
4.3	Comparison of each mode.....	- 27 -
4.4	Normal Mode	- 27 -
4.5	Serial Configuration Mode	- 28 -
4.6	ISP Mode	- 28 -
4.6.1	<i>Upgrading Firmware.....</i>	<i>- 28 -</i>

4.6.2	Revoking Serurity Options.....	- 28 -
5	Communication Modes.....	- 29 -
5.1	TCP Server.....	- 29 -
5.1.1	Key parameters.....	- 29 -
5.1.2	Examples.....	- 30 -
5.2	TCP Client.....	- 33 -
5.2.1	Key parameters.....	- 33 -
5.2.2	Examples.....	- 34 -
5.3	AT Command.....	- 37 -
5.3.1	Key parameters.....	- 37 -
5.3.2	Examples.....	- 38 -
5.4	UDP.....	- 41 -
5.4.1	Key parameters.....	- 41 -
5.4.2	Examples.....	- 42 -
6	System Management.....	- 44 -
6.1	Upgrading Firmware.....	- 44 -
6.1.1	Firmware.....	- 44 -
6.1.2	Processes.....	- 44 -
6.2	Status Monitoring.....	- 46 -
6.2.1	Using TELNET.....	- 46 -
6.2.2	Using ezManager.....	- 48 -
6.3	Factory Reset.....	- 52 -
6.3.1	Using Factory Reset.....	- 52 -
6.3.2	Setting custom default values.....	- 53 -
7	Security Function.....	- 54 -
7.1	SSL.....	- 54 -
7.1.1	What is the SSL(Secure Socekt Layer)?.....	- 54 -
7.1.2	How to set the SSL.....	- 54 -
7.1.3	Restriction.....	- 55 -
7.2	Access Restriction (ezTCP Firewall).....	- 56 -
7.2.1	Setting Password.....	- 56 -
8	Additional Functions.....	- 57 -
8.1	Notify IPv4 Change.....	- 57 -

- 8.2 Sending MAC Address..... - 58 -
- 8.3 Serial Port Tab Functions..... - 59 -
 - 8.3.1 Disable TCP Transmission Delay - ① - 59 -
 - 8.3.2 Separator - ②..... - 59 -
 - 8.3.3 TCP Server / Client mode - ③ - 60 -
- 9 RS485/RS422 Interface..... - 61 -**
 - 9.1 About RS485/RS422 Network - 61 -**
 - 9.2 Configuring an RS485 Network..... - 61 -**
 - 9.2.1 Signal Ground..... - 61 -
 - 9.2.2 Biasing Resistors..... - 61 -
 - 9.2.3 Termination Resistors..... - 62 -
 - 9.3 Configuring an RS422 Network..... - 62 -**
 - 9.3.1 1:1 Configuration - 62 -
 - 9.3.2 1:N Configuration - 62 -
 - 9.3.3 Signal Ground, Biasing and Termination Resistors - 63 -
- 10 Checklist in Trouble..... - 64 -**
 - 10.1 Searching problem with ezManager..... - 64 -
 - 10.2 Connection Problem over TCP/IP..... - 65 -
 - 10.3 Data Communication Problem over the Serial Port..... - 66 -
- 11 Related Material - 67 -**
 - 11.1 Technical Documents - 67 -
 - 11.2 Smart phone Application - 67 -
- 12 Technical Support and Warranty..... - 68 -**
 - 12.1 Technical Support - 68 -
 - 12.2 Warranty..... - 68 -
 - 12.2.1 Refund..... - 68 -
 - 12.2.2 Free Repair Services - 68 -
 - 12.2.3 Charged Repair Services..... - 68 -
- 13 Precaution and Exemption from Liability..... - 69 -**
 - 13.1 Precaution..... - 69 -
 - 13.2 Exemption from Liability..... - 70 -
 - 13.2.1 English version..... - 70 -
 - 13.2.2 French version..... - 71 -

14 Revision History..... - 73 -

1 Overview

1.1 Overview

Almost all communication devices including PC are using serial transmission. In this type, devices send and receive data in the order of each byte. The serial communication is quite simple to implement but has weaknesses like short distance and hard maintenance.

CSE-H55N lets the serial devices connect to the Internet. To communicate on the Internet, devices should use TCP/IP protocol, so CSE-H55N processes the converting serial data to TCP/IP.

1.2 Features

- IPv4 / IPv6 dual stack
- Stateless / Stateful (DHCPv6) address auto-configuration
- RS422/RS485 (Terminal Block)
- Industrial temperature range (-40°C ~ +85°C)
- Variety of monitoring status (ezManager, TELNET)
- Security Protocols SSL3.0/TLS1.0

1.3 Application Examples

- 1:1 Connection with a PC



Figure 1-1 1:1 connection with a PC

- Applied to LANs

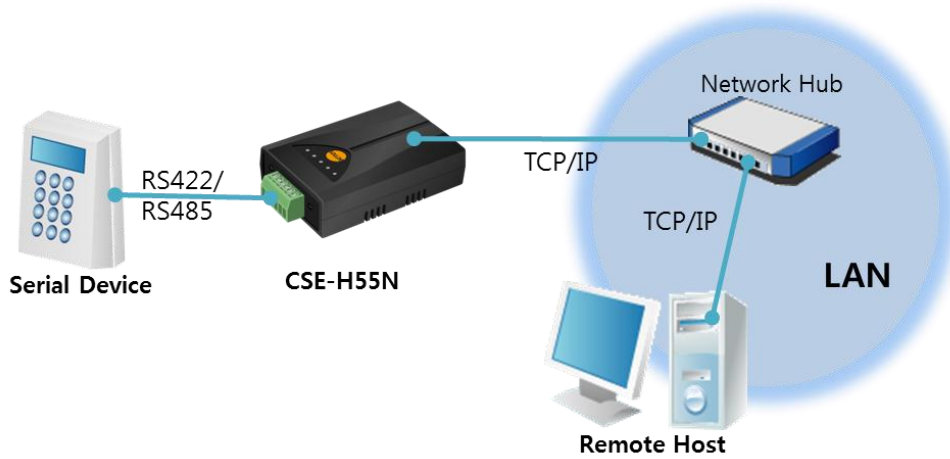

Figure 1-2 applied to LANs

- Applied to the Internet on Cable Networks

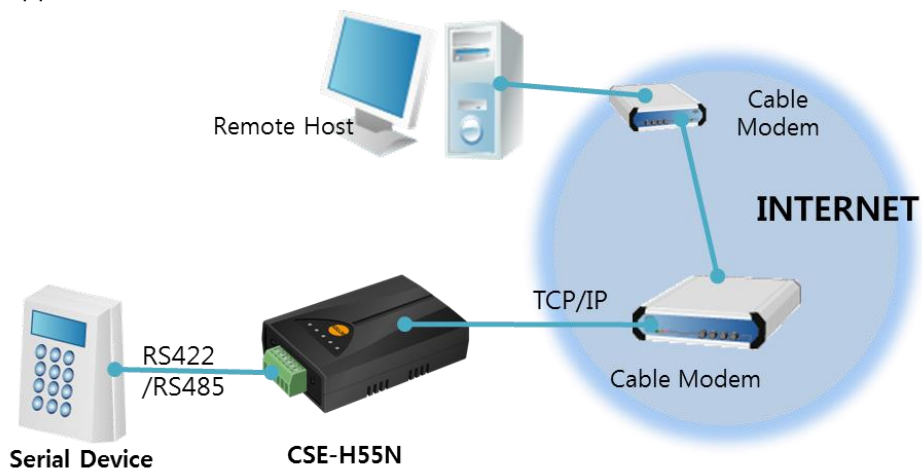

Figure 1-3 applied to the Internet on cable networks

- Applied to the Internet with an IP Share Router

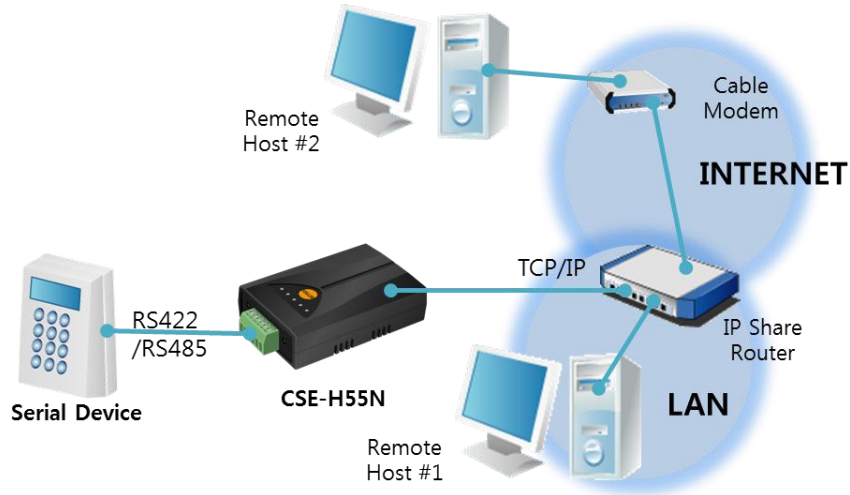

Figure 1-4 applied to the Internet with an IP share router

- Applied to a serial tunneling system

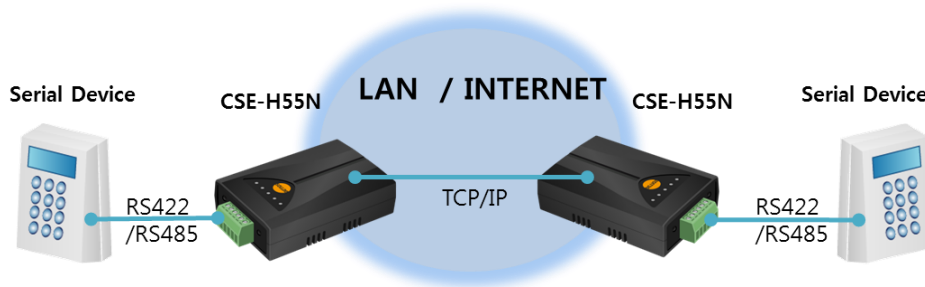

Figure 1-5 applied to a serial tunneling system

- Applied to a multi-drop network.

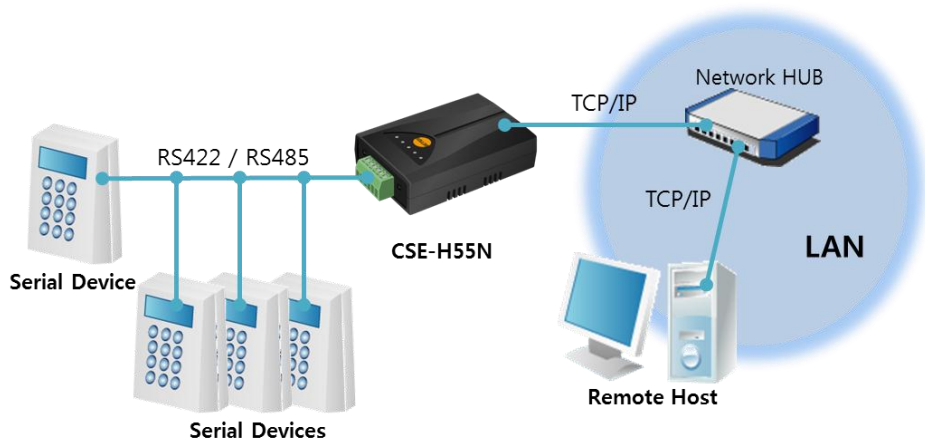

Figure 1-6 applied to a multi-drop network

1.4 Components

- CSE-H55N's Body
- CD, including utilities and documents (option)
- DC 5V Adapter (Option)

1.5 Specification

1.5.1 Hardware

Power	Input Voltage	DC 5V ($\pm 10\%$)
	Current	165mA typical
Dimension	94mm x 57mm x 24mm	
Weight	About 63g	
Serial Port	Serial	RS422 / RS485 (Baud Rate: 1,200bps ~ 230,400bps)
	Network	10 Base-T or 100 Base-TX Ethernet Auto-Sensing Auto MDI or MDIX cable Auto-Sensing
Temperature	Storage / Operating Temperature: -40 ~ 85°C	
Approval	KC, CE	
RoHS	RoHS Compliant	

Table 1-1 Hardware specification

1.5.2 Software

Protocol	TCP, UDP, IPv4/IPv6 dual stack, , ICMPv6/TCPv6/UDPv6 ICMP, ARP, DHCP, PPPoE, DNS, DDNS(Dynamic DNS), Telnet, SSL	
Operation mode	Normal	For Normal Data Communication
	ISP	For Upgrading F/W
	Serial Configuration	For Configuration via Serial
Communication mode	TCP Server	TCP Passive Connection
	TCP Client	TCP Active Connection
	AT Command	TCP Passive / Active Connection
	UDP	UDP
Major Utilities	ezManager	Configuration Utility for MS Windows (Supports Downloading F/W)
	ezVSP	Serial to TCP/IP Virtual driver for MS Windows

Table 1-2 Software specification

1.6 Interfaces

1.6.1 Serial Interface

CSE-H55N has a serial port for user serial device (1,200bps ~ 230,400bps). This port is interfaced with 6-pins terminal block and the each pin should be fixed by a flat-head screwdriver driver.

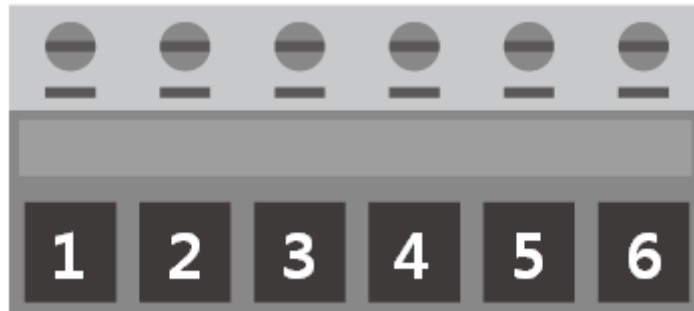

Figure 1-7 6 pins Terminal block

- Pin Assignment for RS-422

Number	Name	Description	Level	I/O	Etc.
1	TX +	Transmit Data +	RS422	OUT	Required
2	TX -	Transmit Data -			
3	GND	Ground	-	-	Required
4	RX +	Receive Data +	RS422	IN	Required
5	RX -	Receive Data -			
6	GND	Ground	-	-	Required

Table 1-3 pin assignment of the RS422

- Pin Assignment for RS-485

Number	Name	Description	Level	I/O	Etc.
1	TRX +	Transmit / Receive Data +	RS485	OUT	Required
2	TRX -	Transmit / Receive Data -		IN	
3	GND	Ground	-	-	Required
6	GND	Ground	-	-	Required

Table 1-4 pin assignment of the RS485

- Serial Port Parameters

Parameter	Value
Number	1
Type	RS422 / RS485
Baud rate	300 ~ 230,400 [bps]
Parity	NONE / EVEN / ODD / MARK / SPACE
Data bit	8 / 7
Stop bit	1 / 1.5 / 2
Flow control	NONE / RTS/CTS

Table 1-5 serial port parameters

1.6.2 Ethernet Interface

Since part of CSE-H55N network is composed of Ethernet, UTP cable may be connected. It will automatically sense 10Mbps or 100Mbps Ethernet and connect itself. It also provides auto MDI/MDIX function that can automatically sense 1:1 cable or cross over cable.



Figure 1-8 RJ45 the Ethernet interface

- RJ45 the Ethernet port interface

Number	Name	Direction
1	TX+	Output
2	TX-	Output
3	RX+	Input
4	-	-
5	-	-
6	RX-	Input
7	-	-
8	-	-

Table 1-6 RJ45 the Ethernet port interface

- Status of the system RJ45 LED

Color	LED status	Description
Yellow	Blinks in every second	Obtaining an IP address
	Blinks 4 times at once	Without obtaining an IP address under DHCP or PPPoE network
	On	Connecting with TCP
Green	On	Connecting with Ethernet
	Off	Not connecting with Ethernet.
	blinks	Data is in network

Table 1-7 LED status on the RJ45 LED

1.6.3 Power

DC 5V is used for the power. The specifications of the power jack are as the following:

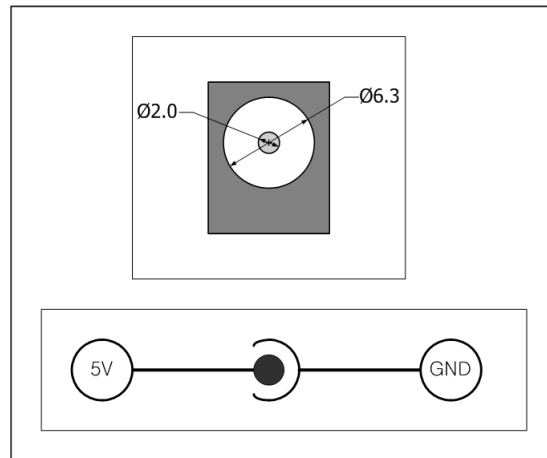

Figure 1-9 power jack

1.7 System LED

CSE-H55N has several lamps to show the current system status.

Each lamp shows the following status:

Mode	Name	Color	Status	Description
Common	PWR	Red	On	Supplying the power
	LINK	Green	On	Connecting with Ethernet
	RXD	Yellow	Blinks	Receiving data from the Ethernet
	TXD	Green	Blinks	Sending data to the Ethernet
Normal mode	STS	Yellow	Blinks in every second	Obtaining an IP address
			Blinks 4 times at once	Without obtaining an IP address under DHCP or PPPoE network
			On	Connecting with TCP
ISP mode	STS	Yellow	Off	Entering ISP mode
Serial Configuration mode	STS	Yellow	Blinks simultaneously	Entering Serial Configuration mode
	LINK	Green		
	RXD	Yellow		
	TXD	Green		

Table 1-8 LED status on the top panel

Mode	Name	Color	Status	Description
Common		Yellow	Blinks	Receiving data from the serial port
		Green	Blinks	Sending data to the serial port

Table 1-9 LED status on the front panel

- ☞ **The green LED on the left side of RJ45 connector is connected to LINK LED and the yellow LED on the right side is connected to STS LED.**

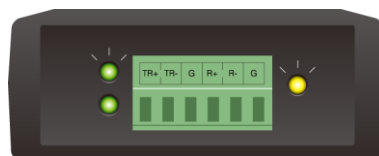

Figure 1-10 the front side panel

1.7.1 Function button

There is a switch, which is named function switch (or button) located on the side of the product. You can change the operation mode of CSE-H55N to ISP or Serial Configuration mode with this switch. And it is used for factory reset.



Figure 1-11 function switch

2 Installation and Test

2.1 Installation

Before testing CSE-H55N, users should connect both serial and Ethernet port to a PC. To connect the RS232 port of your PC and CSE-H55N via serial, you need a RS232 to RS422/RS485 converter. It will be no problem that the Ethernet connection includes network hubs.

In case if your PC doesn't have a RS232 port, use a USB to RS232 cable.

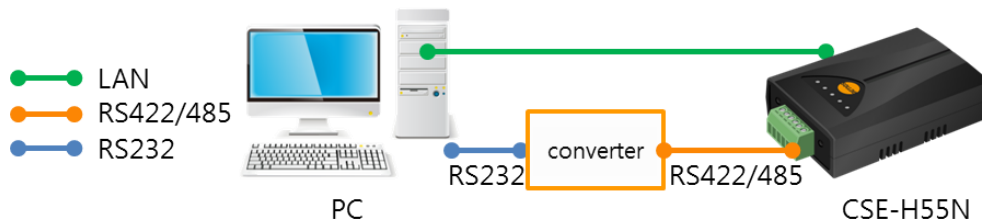

Figure 2-1 connection between CSE-H55N and a PC

2.1.1 Setting Network Area

This step is for setting both CSE-H55N and users' PC to be located the same network. If only they are, the TCP connection between them can be established.

- Setting of the PC

Add or change the IP address of the network adapter on your PC like following.

Get into the menu of [Windows Control Panel] >> [Network Connections] >> [Properties of the Network Adapter – with right click of your mouse]. Then, you can show the properties of [Internet Protocol (TCP/IP)]. In there, press the [Advanced..] button for adding an IP Address like the below figure.

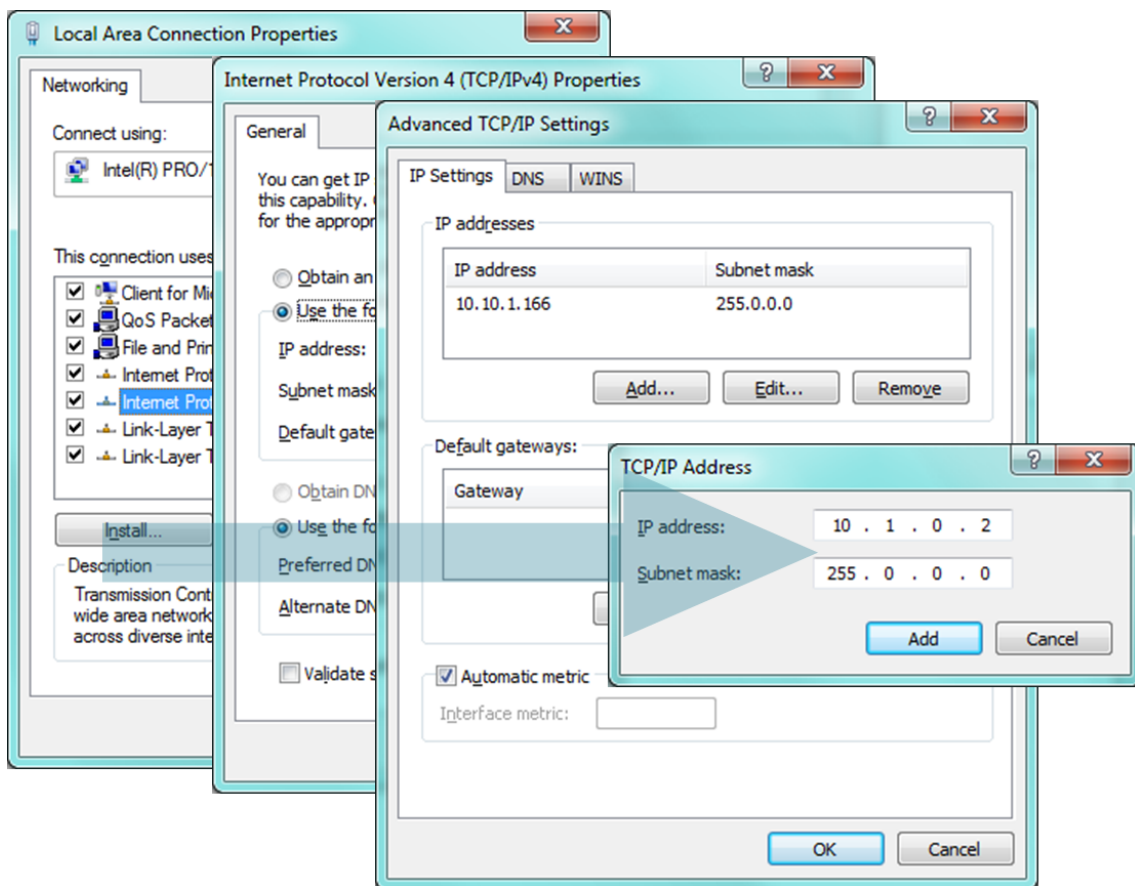

Figure 2-2 adding / changing the IP address of users' PC

- Setting of CSE-H55N

CSE-H55N uses ezManager as it's a configuration program. ezManager is for MS Windows, and this is comfortable to use because it doesn't need installation. First, search your CSE-H55N via network. All the values of parameters are set the default values in the factory. To apply it to your system, proper values should be set via ezManager. Major parameters' default values are listed on below table. To implement this simple test, keep these values without any changes.

Name		Default Values
Network	Local IP Address	10.1.0.1
	Subnet Mask	255.0.0.0
	IPv6	Disable
Option	TELNET	Checked
	IP Address Search	Checked
Serial Port (COM1)	Serial Type	RS485
	Baud Rate	19,200bps
	Parity	NONE
	Data Bits	8
	Stop Bit	1
	Communication mode	TCP Server
	Local Port	1470

Table 2-1 default values of Major parameters

☞ ***Refer to ezManager website for more details.***

2.2 Simple Test

If you press the [Simple Test] button, test program will be shown on your screen.

- Connecting to the CSE-H55N via LAN

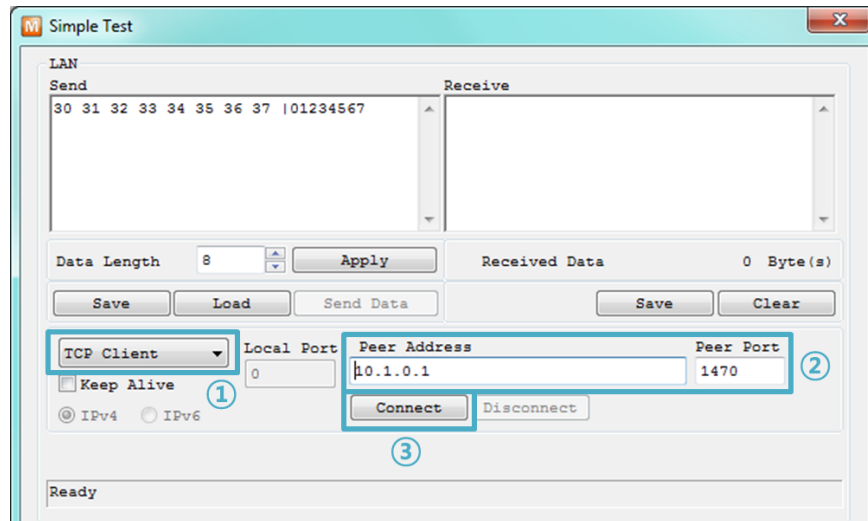

Figure 2-3 settings for TCP connection

- ① Select [TCP Client]
 - ② Input correct IP address and port number of CSE-H55N
 - ③ Click the [Connect] button. (In case of TCP Server, it will be [Listen] button)
- Opening RS232 Port

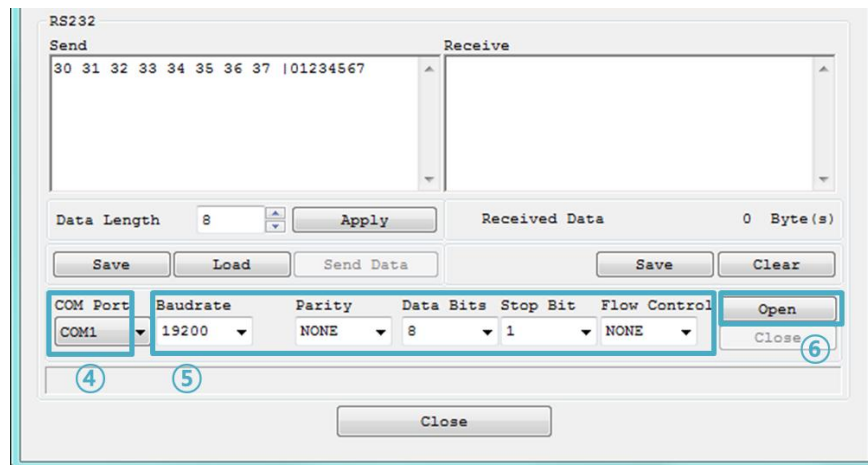

Figure 2-4 opening COM Port

- ④ Select COM port where the CSE-H55N is being connected.
- ⑤ Make sure that all the parameters are the same with CSE-H55N.
- ⑥ Press the [Open] button

- Confirm the TCP Connection and COM port status

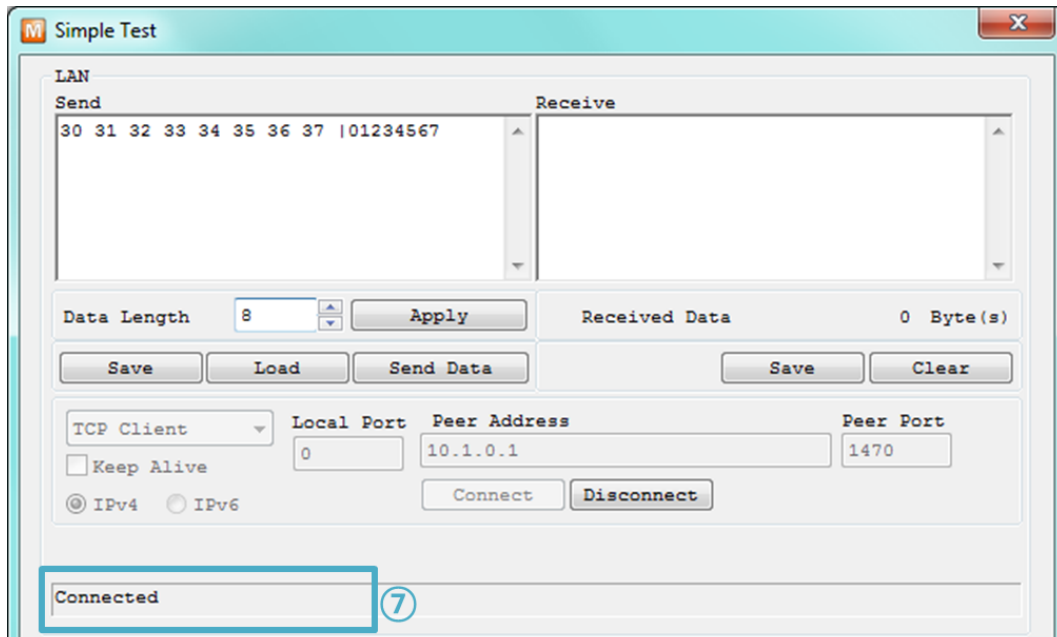

Figure 2-5 TCP Connected message

- ⑦ Check the message if the TCP connection has been established well.

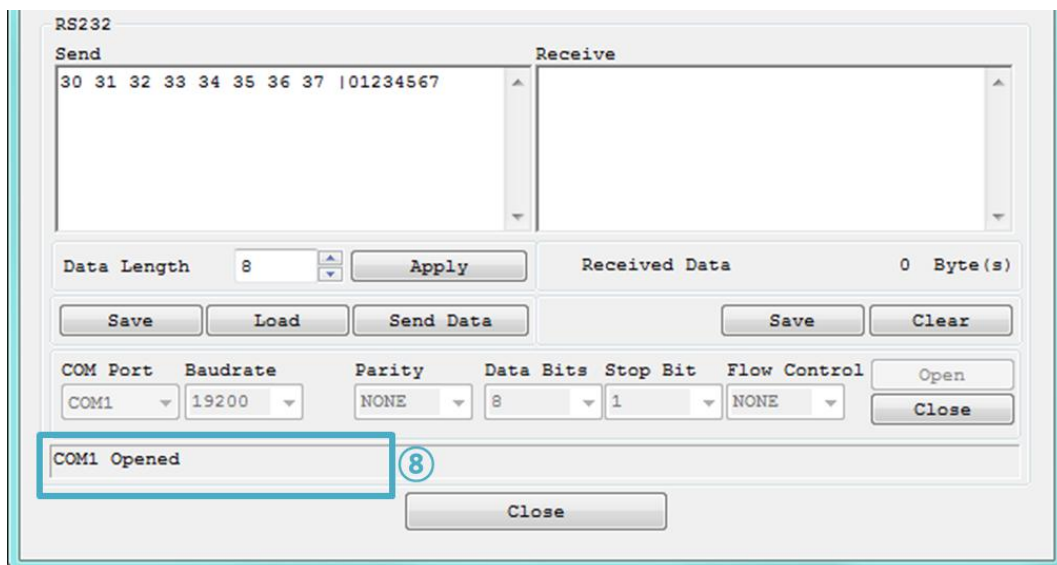

Figure 2-6 COM Port open message

- ⑧ Check the message if the COM port has been opened

● Data transmission test

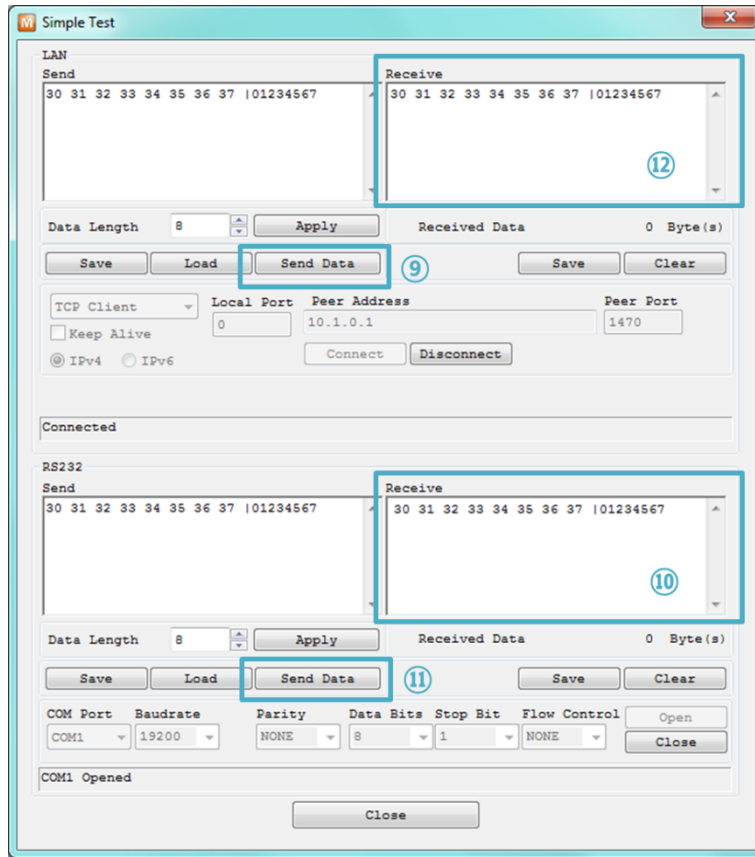

Figure 2-7 successful data transmission

- ⑨ Click the [Send data] on the LAN side.
- ⑩ Check the data have been shown from the step ⑨.

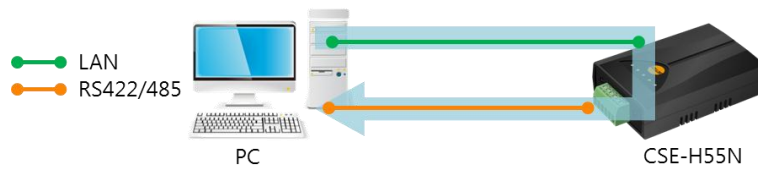

Figure 2-1 LAN → RS232

- ⑪ Press the [Send data] on the RS232 side.
- ⑫ Check the data from ⑪ has been received.

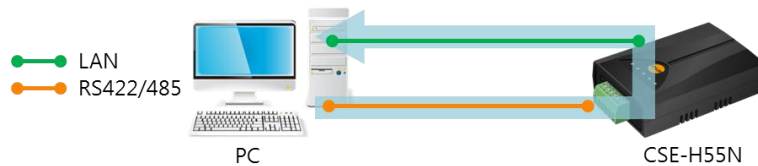

Figure 2-2 RS232 → LAN

3 Configuration

3.1 Configuration with ezManager

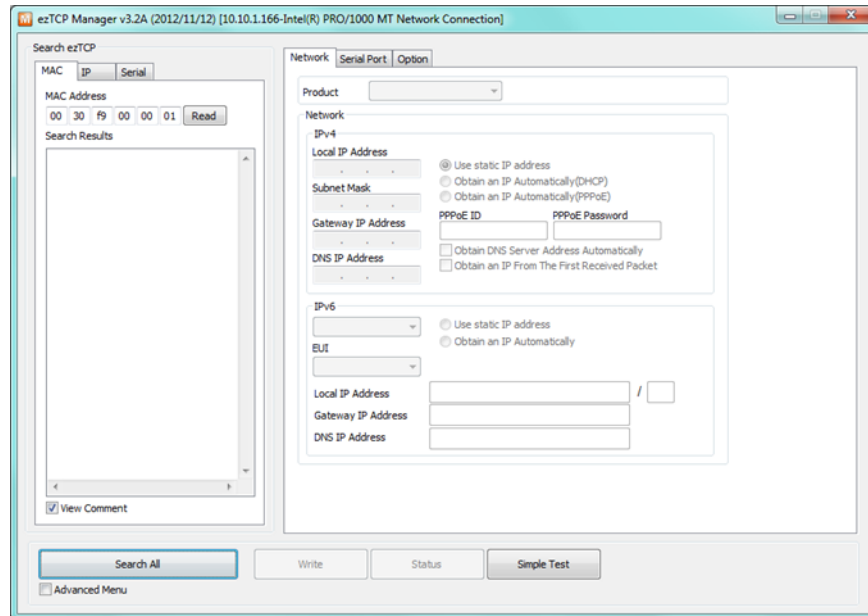

Figure 3-1 initial appearance of ezManager

3.1.1 Configuration via LAN

- Checklists

Make sure the connection between your PC and CSE-H55N. If they are the same network, [MAC Address search] button can be used. If they aren't, only [IP Address search] is allowed to use.

- Procedures

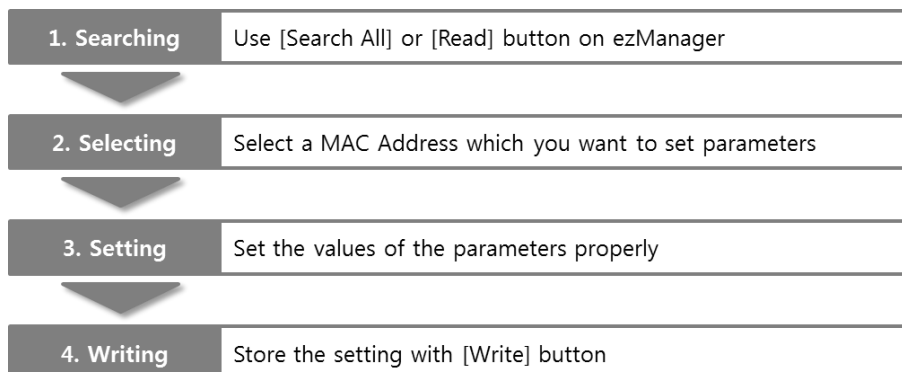

Figure 3-2 procedures for configuration via LAN

3.1.2 Configuration via Serial

- Checklists

To use serial configuration, COM port of PC should be connected with CSE-H55N. Because CSE-H55N doesn't have a RS232 port, a RS232 to RS422/485 converter is needed. Of course, CSE-H55N should be in operation as [Serial Configuration Mode].

- Procedures

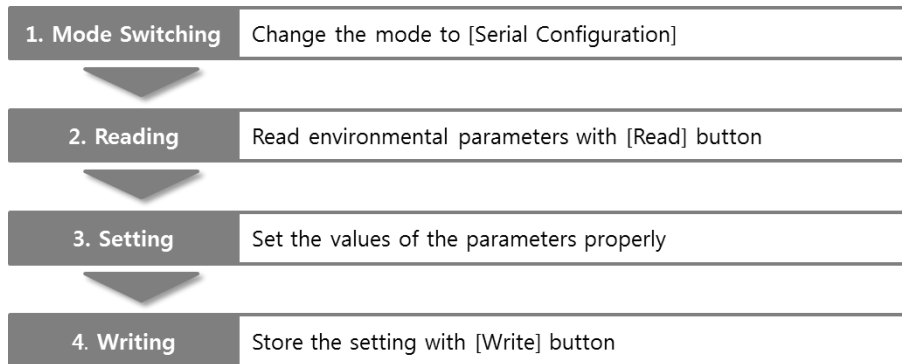

Figure 3-3 procedures for configuration via Serial

- Step 2, Reading

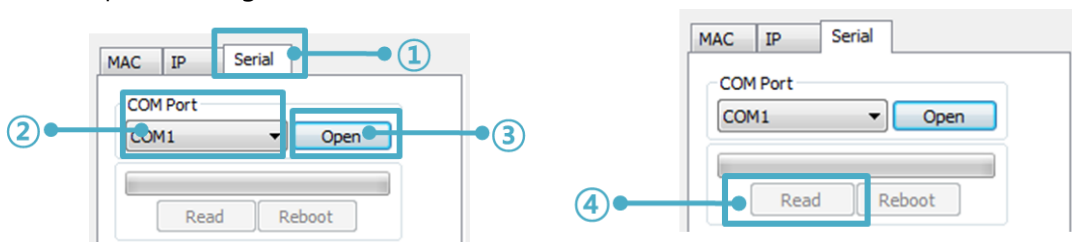

Figure 3-4 reading procedure via serial

- ① Choose the [Serial] tab
- ② Select the COM port which the CSE-H55N is connected with
- ③ Open the COM port with the [Open] button
- ④ Load the setting with [Read] button

Refer to the [ezManager] manual on our website for details.

You can download ezManager application for a smartphone on our website.

3.2 AT command

In the AT command mode, you can change some parameters through the serial port.

- Checklists

Make sure the connection between your PC and CSE-H55N using RS232 cross cable. To use this, CSE-H55N has to be set to [AT command] mode as its communication mode. This can be configured by ezManager.

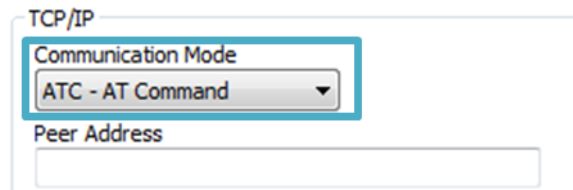

Figure 3-5 setting the communication mode to the AT command

- Procedures

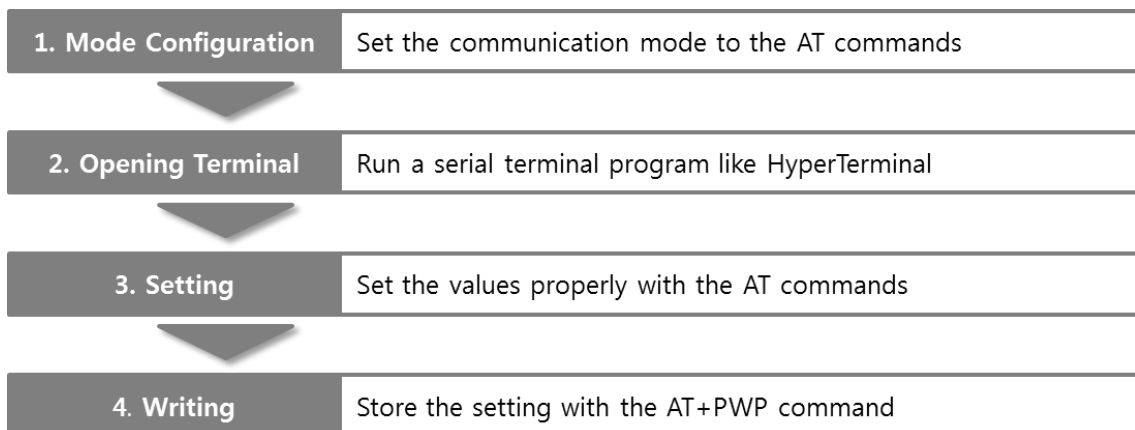

Figure 3-6 procedures for configuration with AT command

Division	Available parameters
IP Address related items	Local IP Address, DHCP, PPPoE, Subnet Mask, Gateway IP Address, DNS IP Address, ...
TCP connection related items	Local Port, Peer Address (IP Address or Host name), Peer Port, ...
Option	ESC code sending option, timeout, ...

Table 3-1 parameters which are available to change with AT command

☞ ***Including above items, rest of parameters can be set by ezManager***

4 Operation Modes

4.1 What is the Operation Mode?

Each of three operation mode of CSE-H55N is defined for specific purpose, and those are followed.

- Normal mode
This mode is for normal data communication and has 4 different connection modes. Configuring parameters is also available in this mode.
- Serial configuration mode
This mode is for configuring environmental parameters through the RS-422 port.
- ISP mode
This mode is for upgrading firmware. In addition, you can set environmental parameters even though the security options like password are activated by entering this mode.

4.2 How to entering each mode

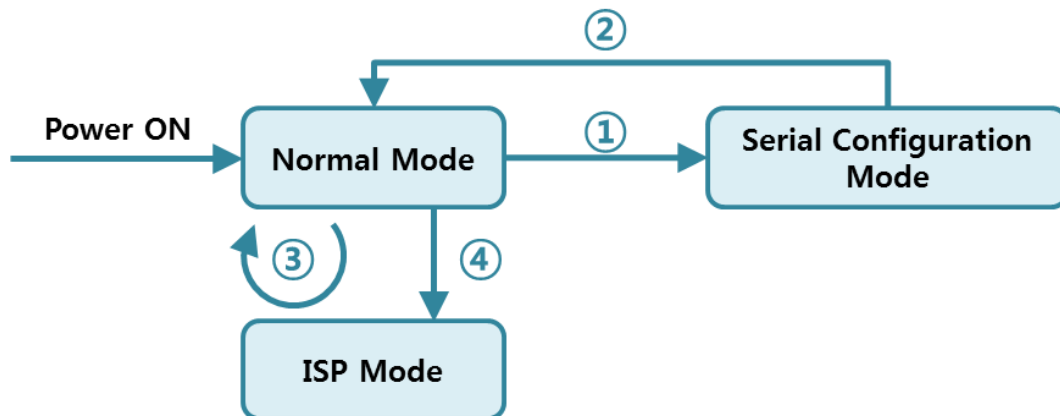

Figure 4-1 How to entering each mode

- ① Push the function button less than 1 second.
- ② Reset
- ③ Transfer a firmware by ezManager
- ④ Push the function button over than 1 second.

4.3 Comparison of each mode

Name	Serial port	Serial type
Normal	configured value	RS422 / RS485
Serial Configuration	115,200/N/8/1	RS422
ISP	-	-

Table 4-1 comparison of each mode

4.4 Normal Mode

In normal mode, there are four connection types to communication with a remote host.

- TCP Server
- TCP Client
- AT Command
- UDP

Name	Protocol	Connection	Modifying software of serial devices	Serial configuration	Topology
TCP Server	TCP	Passive	-	Unavailable	1:1
TCP Client		Active	-	Unavailable	1:1
AT Command		Either	Required	Available	1:1
UDP	UDP	-	-	Unavailable	N:M

Table 4-2 comparison of four communication modes

TCP is a type of protocol, which has a process of connection. The connection has to be one to one. The part who tries to make the connection is called TCP Client, and the other part is TCP Server. On the other hand, UDP has no connection process. Because of this, each of them can be send and receive data from multiple hosts.

4.5 Serial Configuration Mode

This mode is for setting environmental parameters through the serial port. ezManager has an interface for this mode. Use the [Read] button on the [Serial] tab.

4.6 ISP Mode

You can enter this mode by pressing the function button over 1 seconds. There are two special purposes in this mode.

4.6.1 Upgrading Firmware

ISP mode is for upgrading firmware which is offered by us. The upgrade is implemented on Ethernet.

☞ *The details are followed in the ["6.1 Upgrading Firmware"](#).*

4.6.2 Revoking Security Options

CSE-H55N offers restriction methods for security like filtering password or MAC and IP address. In the ISP mode, you can revoke all of these. When you forgot the password, enter the ISP mode to solve the problem.

☞ *When you change the environment values on the ISP mode, a part of values may randomly change. If you quit the configuration, please check again on the normal mode*

5 Communication Modes

5.1 TCP Server

In this mode, CSE-H55N listens to a TCP connection request from remote hosts. Once a host tries connecting to CSE-H55N, it accepts a connection. After the connection is established, CSE-H55N converts the raw data from the serial port to TCP/IP data and sends it to the network and vice versa.

5.1.1 Key parameters

- Local Port
This is a server's port number which is used in the TCP connection.
- Event Byte
- With setting event bytes, you can handle the serial data of the serial buffer before a TCP connection is established.

Value	Description
0	CSE-H55N doesn't send the data
Otherwise (512 or under)	CSE-H55N sends the data right after a connection is established. 512 or under bytes are strongly recommended.

Table 5-1 Event Byte

- Timeout
If there is no transmission data for amount of the time the connection would be terminated.
- Notify IP Change
This function is for notifying information about changed IP addresses to a management server. Not only can the TCP/UDP protocol be used, but Dynamic Domain Name Service (DDNS).
- Access restriction
You can block TCP connections from unauthorized hosts by using this option. Both IP and MAC address are available.

5.1.2 Examples

- A situation that [Event Byte] is set to 0.

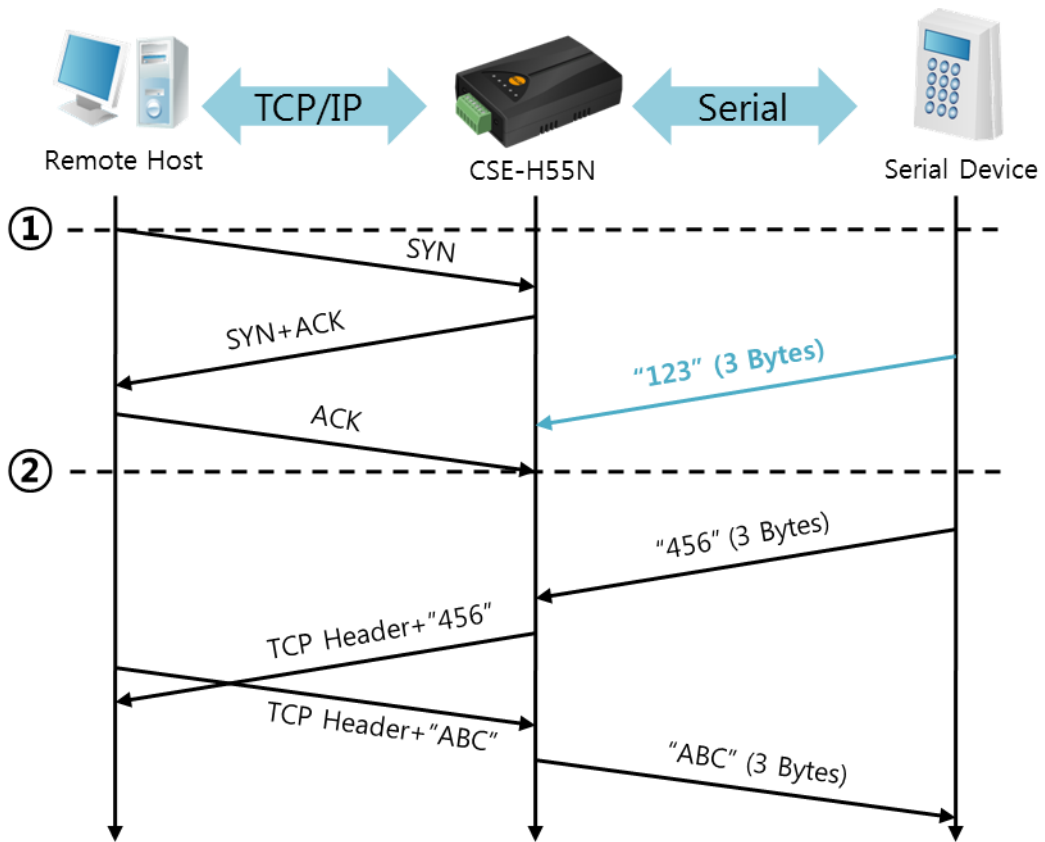

Figure 5-1 time chart

Points	States
~	CSE-H55N is listens to connection requests
①	Remote host sends a connection request (SYN) segment
~	Processes of the connection
②	The connection is established
~	Data communication is implemented on both side

Table 5-2 states of each point

Look at the blue arrow. The data "123" from the serial port has been sent before establishing a connection. In this case, the data would not be sent because of the [Event Byte] is set to 0.

- A situation that [Event Byte] is set to 1.

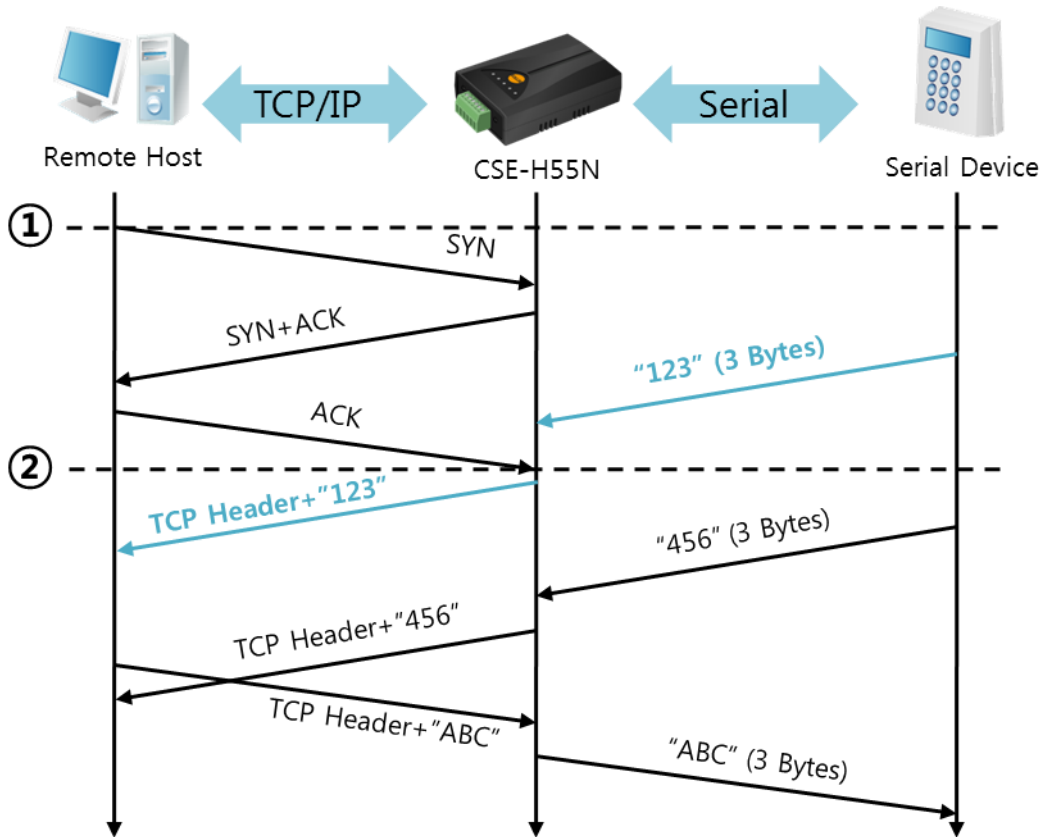

Figure 5-2 time chart

Points	States
~	CSE-H55N listens connection requests
①	Remote host sends a connection request (SYN) segment
~	Processes of the connection
②	The connection is established
~	Data communication is implemented on both sides

Table 5-3 states of each point

As you can see, the data "123" has been sent right after establishing a connection because the value of [Event Byte] had been set to 1.

- A situation that [Timeout] is set to 5.

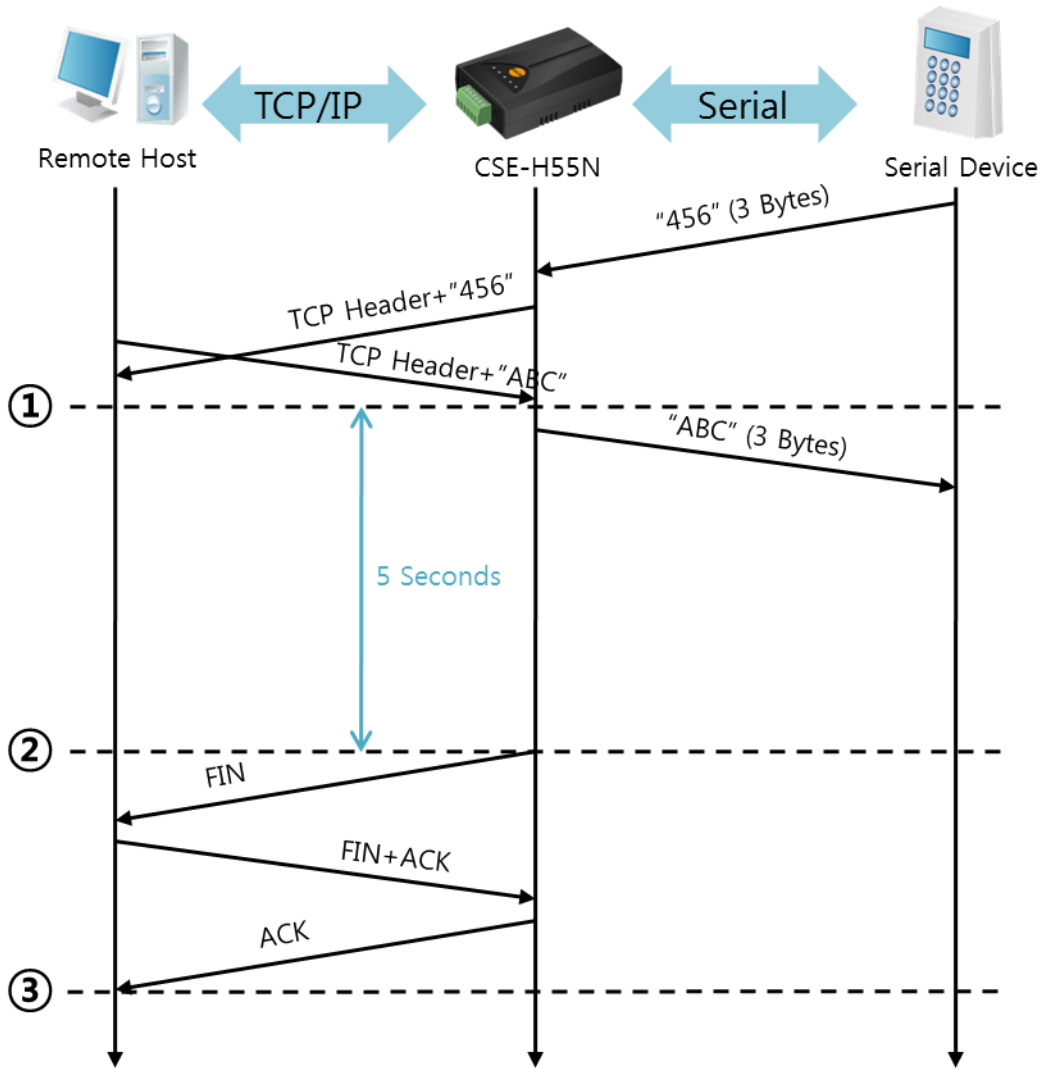

Figure 5-3 time chart

Points	States
~	Data communication on both sides
①	The last segment arrives at the CSE-H55N
~	No data communication for 5 seconds
②	CSE-H55N send disconnection request (Fin) to a remote host
~	Processes of the disconnection
③	The connection is terminated
~	CSE-H55N listens connection requests

Table 5-4 states of each point

5.2 TCP Client

In this mode, CSE-H55N sends request segments to a TCP server with information of [Peer Address] and [Peer Port]. Once a host is listening, the connection will be established. After then, CSE-H55N converts the raw data from the serial port to TCP/IP data and sends them to the network and vice versa.

5.2.1 Key parameters

- Peer Address

This item is an address of TCP server

- Peer Port

[Peer Port] is a port number of TCP server.

- Event Byte

This item can decide the point of time to send the connection request parameter.

Value	Description
0	Right after CSE-H55N boots up
Otherwise (512 or under)	right after the bytes set to [Event Byte] have been received from the serial port Setting to less than 512 bytes is strongly recommended.

Table 5-5 the operation of Event Byte 1

In addition, you can handle the serial data before a TCP connection is established with this parameter.

Value	Description
0	CSE-H55N does not send the data
Otherwise (512 or under)	CSE-H55N sends the data right after a connection is established. Setting to less than 512 bytes is strongly recommended.

Table 5-6 the operation of Event Byte 2

- Timeout

If there is no data transmission for amount of the time the connection would be terminated.

- TCP Server

This check option enables you to get to the TCP Server / Client mode. In this mode, CSE-H55N can be operated as a TCP server or client without changing its settings.

- DNS IP Address
[DNS IP Address] needs when you use host name instead of the IP address.

5.2.2 Examples

- A situation that [Event Byte] is set to 0.

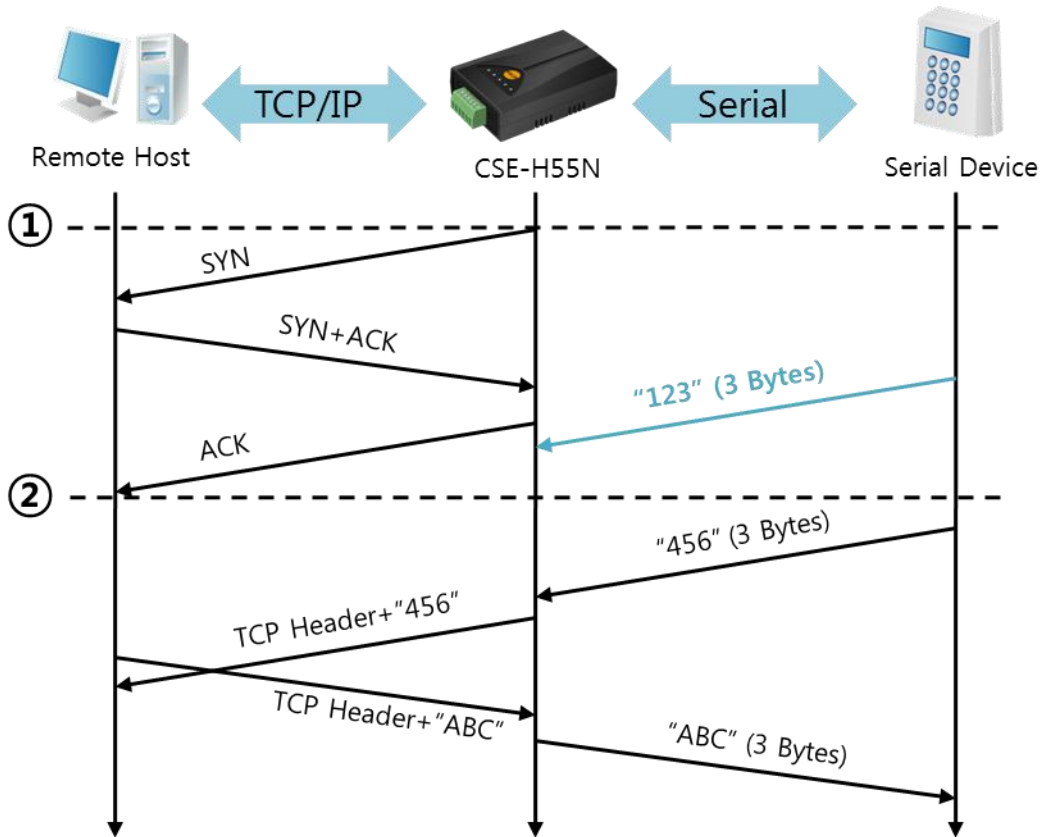

Figure 5-4 time chart

Points	States
~	Power is not supplied yet.
①	CSE-H55N sends a connection request segment right after it boots up
~	Processes of TCP connection
②	The connection is established.
~	Data communication on both sides

Table 5-7 state of each point

Look at the blue arrow. The data "123" from the serial port was sent before establishing a connection. In this case, the data would not be sent because of the [Event Byte] is set to 0.

- A situation that [Event Byte] is set to 5.

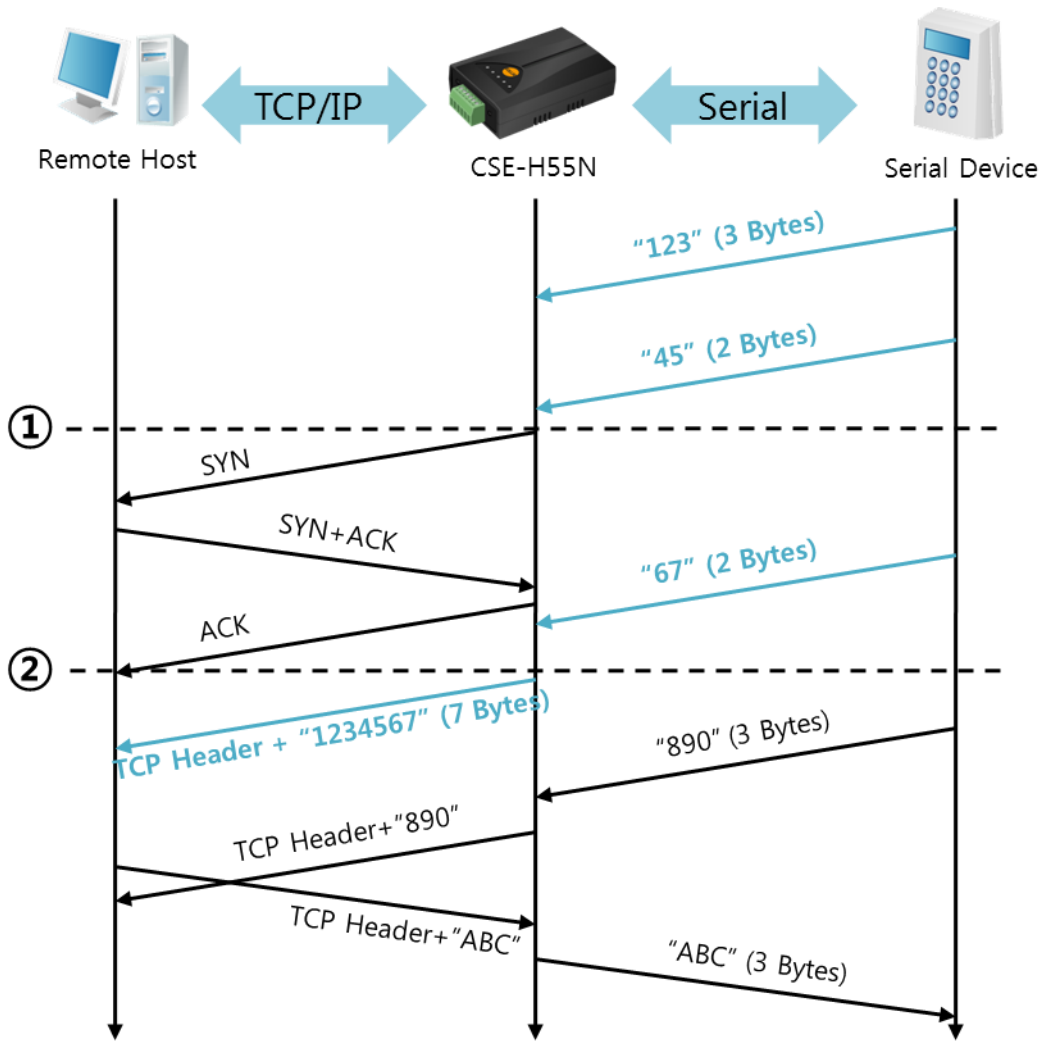

Figure 5-5 time chart

Points	States
~	CSE-H55N receives data from its serial port.
①	CSE-H55N sends a connection request segment right after receiving 5 bytes.
~	Processes of the TCP connection
②	The connection is established
~	The data "1234567" is transmitted to the remote host

Table 5-8 states of each point

As you can see, CSE-H55N has sent a request segment right after the size of the serial data has been 5 bytes. Even though they arrived before the connection, the data "123", "45" and "67" was transmitted to the remote host because the [Event Byte] is set to 5.

- An activated [TCP Server] option

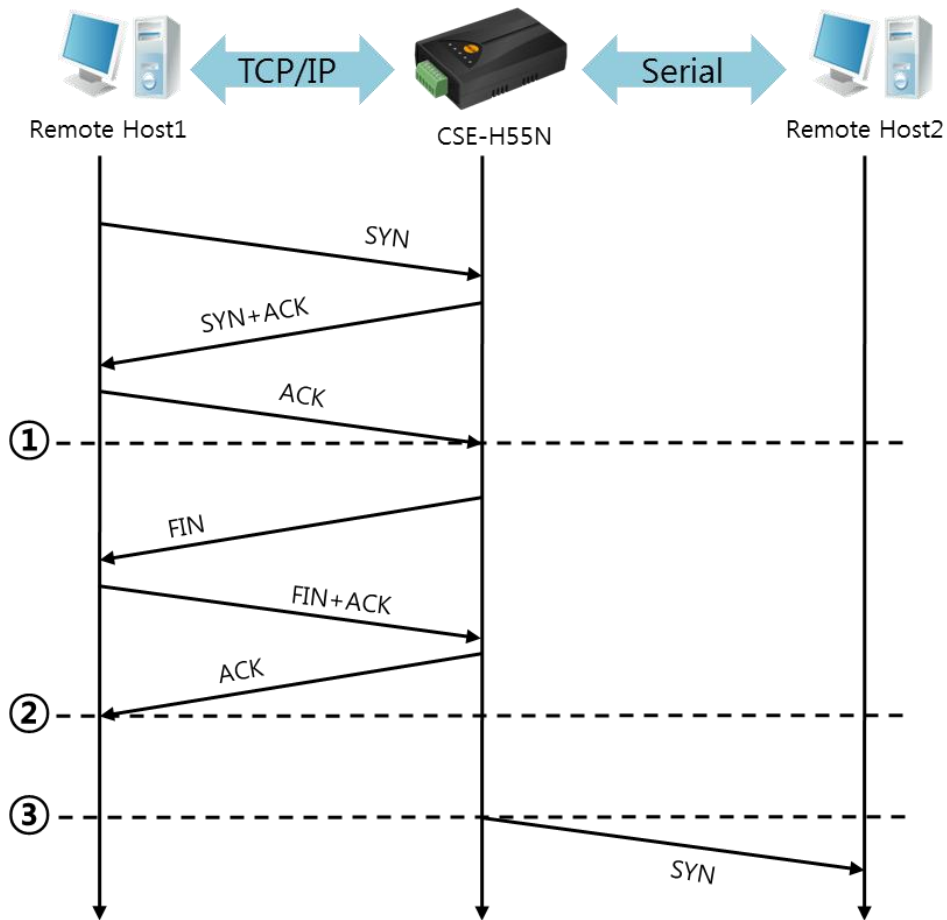

Figure 5-6 time chart for activating [TCP Server] option

Points	States
~	CSE-H55N is listening to connection requests
①	The connection has been established
~	CSE-H55N is on line and processes of the disconnection
②	The connection has been terminated
~	Both sides are offline
③	Sends TCP connection request segment

Table 5-9 state description

The TCP Server / Client mode can be useful option by using [Event Byte] and [Timeout]. Note that only one TCP connection can be established at the same time, so users should consider setting [Timeout] properly.

☞ **Refer to the [TCP server/Client mode] manual on our website for details.**

5.3 AT Command

AT command is a mode which users control CSE-H55N with AT command like controlling modem. In this mode, active and passive TCP connections are available. And users are allowed to configure some environmental parameters with extended commands.

5.3.1 Key parameters

The configuration should be implemented via the serial port of CSE-H55N

Commands	Description	Examples
+PLIP	Local IP Address	at+plip=10.1.0.1<CR>
+PLP	Local Port	at+plp=1470<CR>
+PRIP	Peer IP Address	at+prip=10.1.0.2<CR>
+PRP	Peer Port	at+prp=1470<CR>
+PDC	DHCP	at+pdc=1 (ON)<CR>
+PPE	PPPoE	at+ppe=1 (ON)<CR>
+PTO	Timeout	at+pto=10<CR>
+PWP	Store setting	at+pwp<CR>

Table 5-10 some of extended commands for configuration

- Related items with IP Address and Local Port
Local port can be set as well as IP address related parameters like IP Address, Subnet Mask and Gateway IP Address.
- Peer Address / Peer Port
IP address and local port of a remote host are can be set.
- Type of assigning IP address: Manual, DHCP, PPPoE
Not only manual setting, also automatic assigning protocol (DHCP, PPPoE) are available.
- Others
Some of options including [Timeout] can be configured in this mode.

5.3.2 Examples

- TCP Server – setting parameters and passive connection

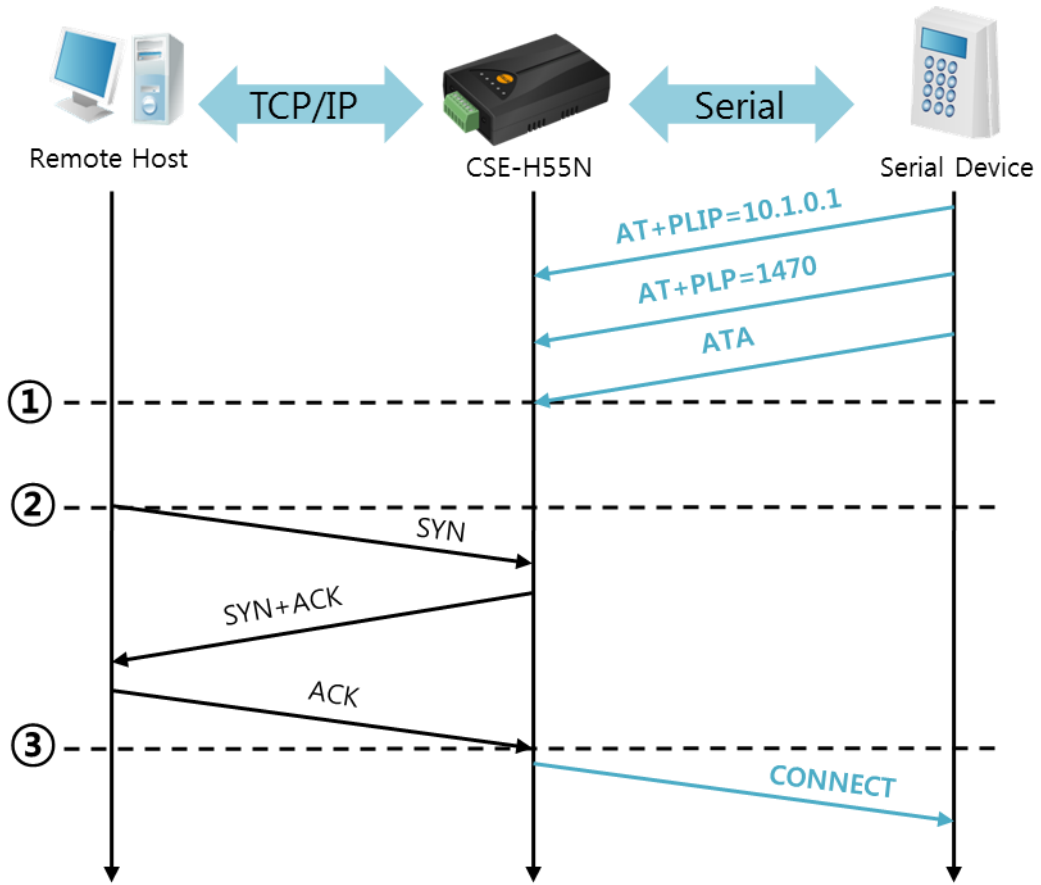

Figure 5-7 time chart

Points	States
~	configuring parameters with AT commands
①	ATA command has arrived.
~	CSE-H55N listens to TCP connection requests.
②	A remote host sends SYN segment to CSE-H55N
~	Processes of TCP connection
③	TCP connection is established
~	CSE-H55N sends "CONNECT" message to the serial port

Table 5-11 state of each other

☞ Refer to the [At Command(ATC) Mode] document on our website for details.

- TCP Client – setting parameters and active connection

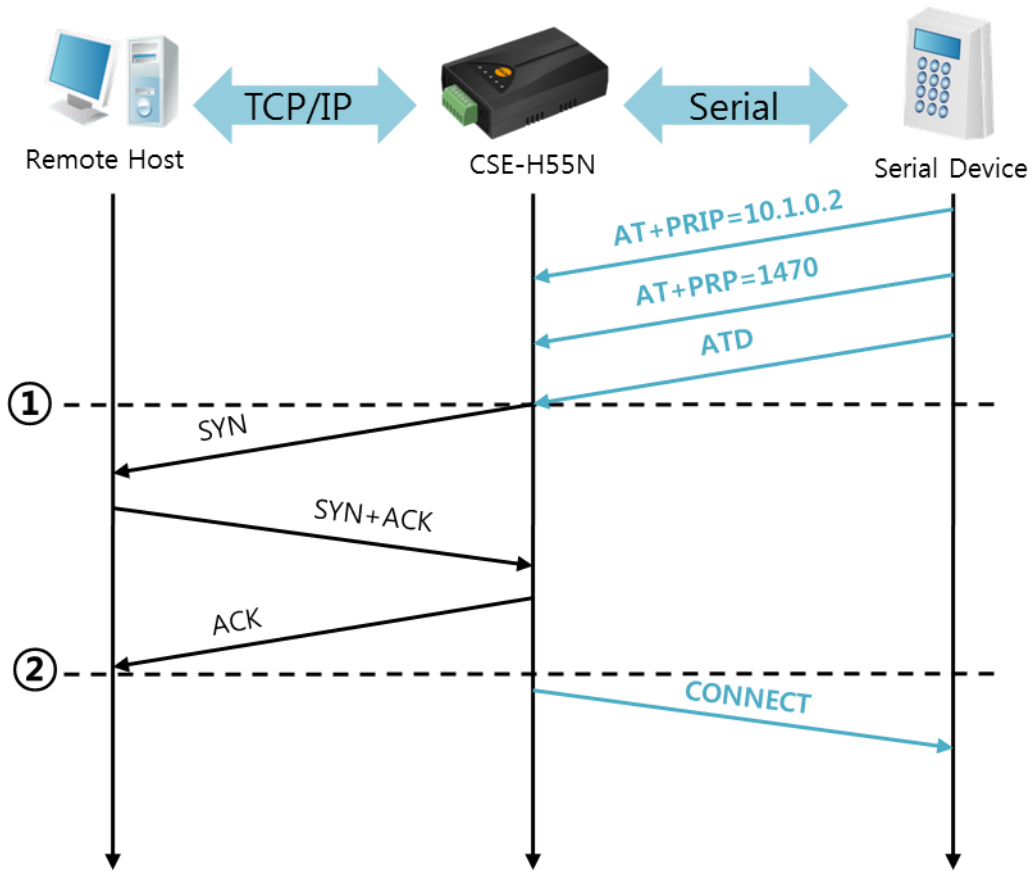

Figure 5-8 time chart

Points	States
~	configuring parameters with AT commands
①	CSE-H55N sends a TCP connection request with the ATD command
~	Processes of TCP connection
②	TCP connection is established
~	CSE-H55N sends "CONNECT" message to the serial port

Table 5-12 state of each other

- Termination of online status – entering the AT command mode

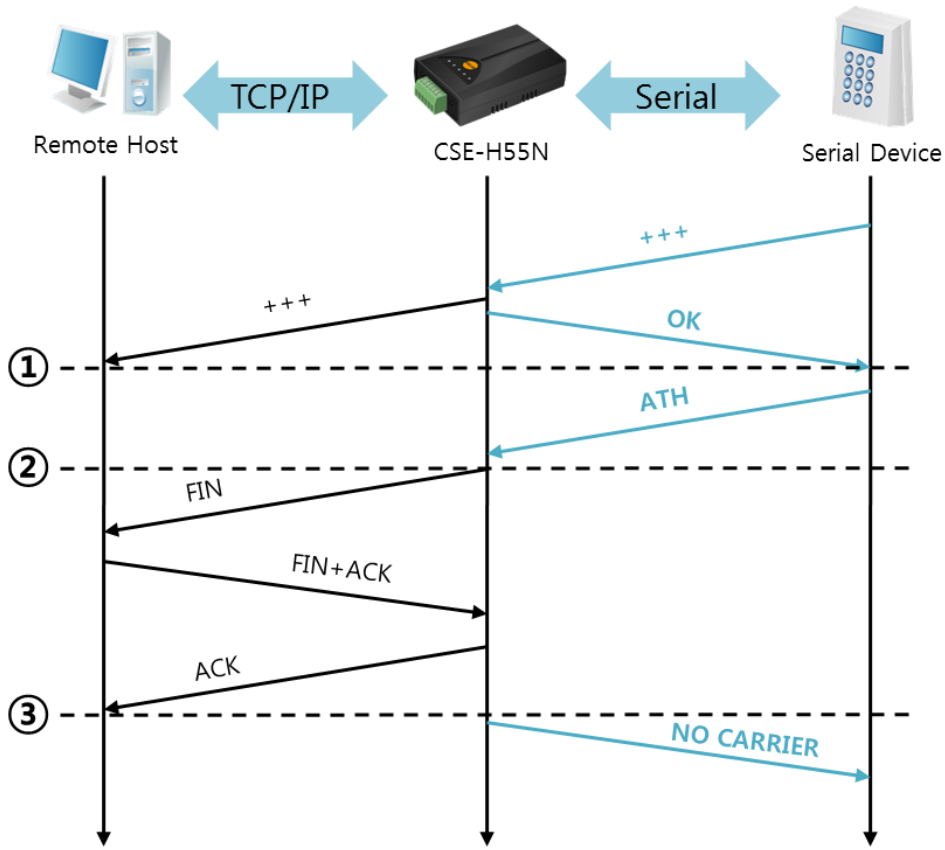

Figure 5-9 time chart

Points	States
~	TCP connection is on-line.
①	The mode is changed to "command mode" after receiving "+++".
~	command mode (TCP connection is off-line)
②	CSE-H55N sends FIN segment right after the "ATH" arrives.
~	Processes of TCP disconnection
③	TCP connection is terminated
~	CSE-H55N sends "NO CARRIER" with disconnection

Table 5-13 states of each other

CSE-H55N changes the mode to AT command, when receiving "+++". In this state, the communication with remote host is unavailable because CSE-H55N processes only AT commands. Whenever you want to go back to on-line state, just give "ATO" command.

☞ **Refer to the [ATC mode] document on our website for details.**

5.4 UDP

UDP has no connection processes. In this mode, data is sent in block units. Therefore, data that comes through CSE-H55N's serial port is collected in block units to send it elsewhere.

5.4.1 Key parameters

- Block Size(Byte)

[Block Size(Byte)] is to set the time to gather data in one block. Its unit is byte. If the data in configured size of the [Block Size(Byte)] comes into the serial port, CSE-H55N will send them as one block to the network. The maximum value could be 1460 bytes.

- Dynamic update of Peer host

If you set the value of [Peer Address] and [Peer Port] to 0, [dynamic update of peer host] function is activated. By using this function, CSE-H55N can communicate to multiple hosts without additional setting.

5.4.2 Examples

- Block Size: 5 bytes

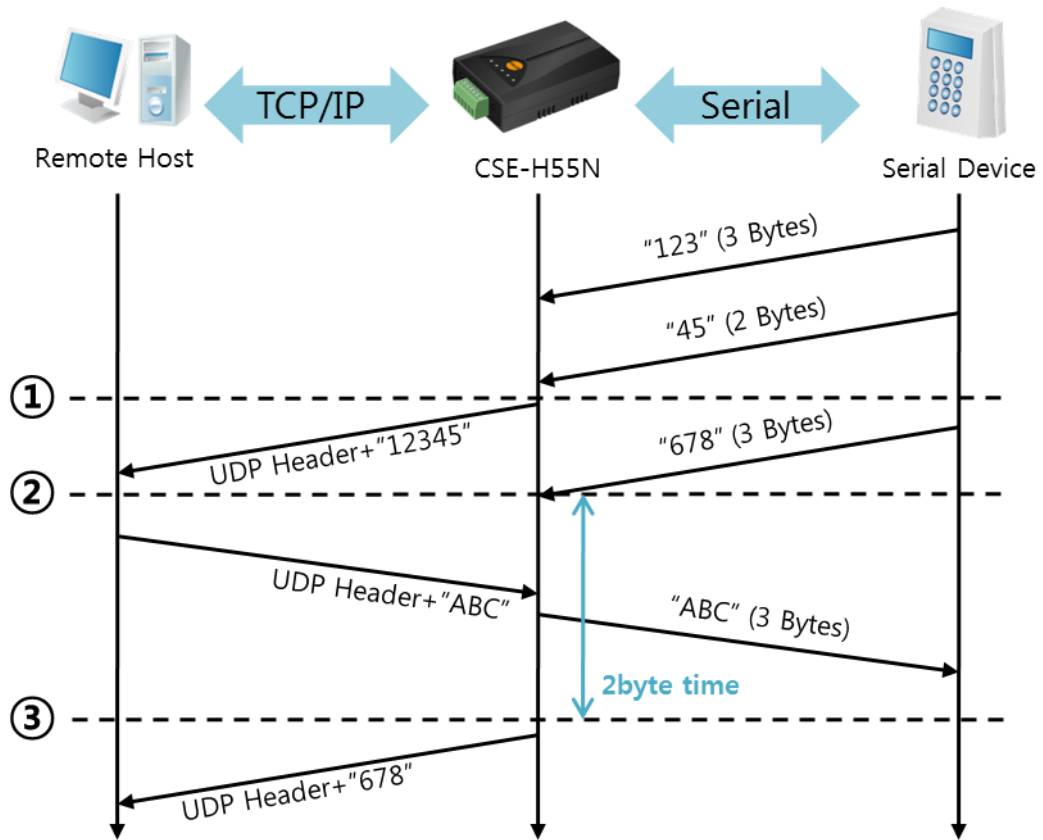

Figure 5-10 time chart

Points	States
~	CSE-H55N receives data from the serial port
①	CSE-H55N sends 5 bytes as one block based on the [Event byte].
~	Serial device sends data "678".
②	The data "678" arrives.
~	CSE-H55N sends data from the remote host to the serial device
③	2byte time has passed
~	CSE-H55N sends data "678" as one block based on the [Data frame].

Table 5-14 state of each point

- Dynamic Update of Peer host

This is a function that CSE-H55N automatically sets its peer host with information of the last packet received from network. The source address of the packet is set to the peer host.

Parameters	Values
Peer Address	0 (None)
Peer Port	0

Table 5-15 setting for [dynamic update of peer host] function

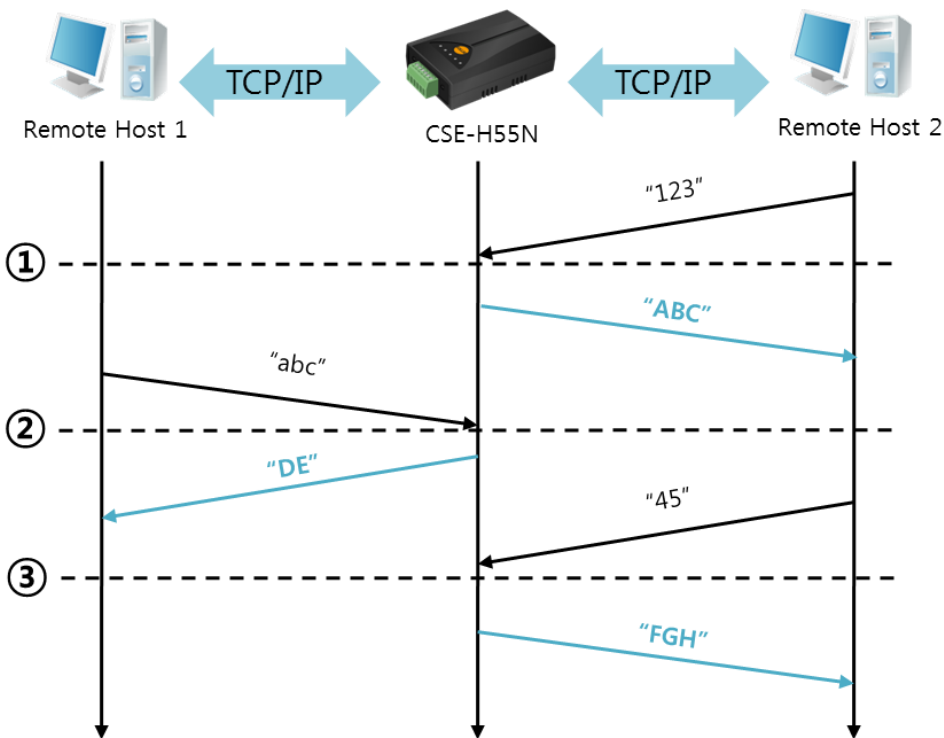

Figure 5-11 time chart

Points	States
~	Sending any UDP data to the network is impossible.
①	UDP data arrives from Remote Host 2.
~	Send UDP data to Remote Host 2.
②	UDP data arrives from Remote Host 1.
~	Send UDP data to Remote Host 1.
③	UDP data arrives from Remote Host 2.
~	Send UDP data to Remote Host 2.

Table 5-16 state description

☞ **The data "ABC", "DE", "FGH" are from the serial port of CSE-H55N in the Figure 5-11.**

6 System Management

6.1 Upgrading Firmware

6.1.1 Firmware

Firmware is a type of software for operation of CSE-H55N. If there are needs for adding function or fixing bugs, the firmware is modified and released. We recommend that users keep use the latest released firmware.

6.1.2 Processes

- Downloading the latest released firmware
Download the newest firmware file. We update our homepage when a new firmware is released. You can find it on our website.
- Entering ISP mode
Enter ISP mode to download firmware file to CSE-H55N.
- Run a TFTP client and ready to send the F/W file
Run a TFTP client program. ezManager is equipped the client program. Click the [Change F/W / HTML] button.

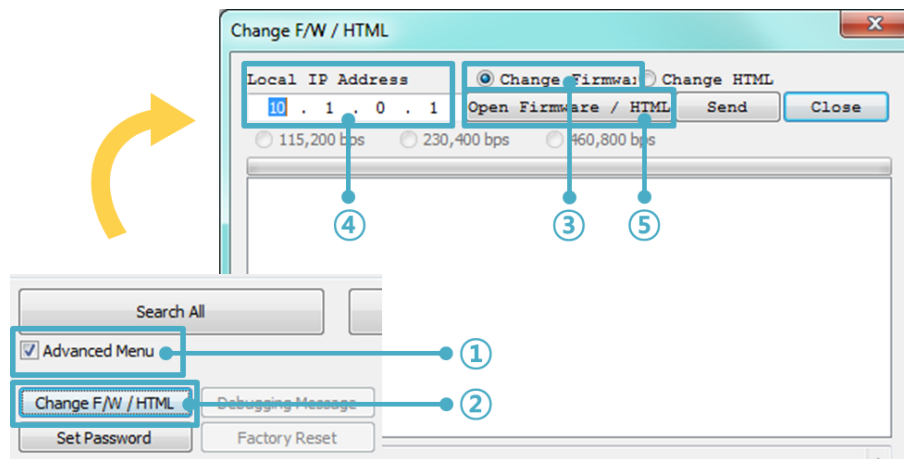

Figure 6-1 running TFTP client

- ① Check the [Advanced Menu] check box
- ② Click the [Change F/W / HTML] button to run TFTP client
- ③ Select the [Change Firmware] radio button
- ④ Input the IP address of CSE-H55N to the [Local IP Address] text box
- ⑤ Press the [Open Firmware / HTML] button and choose the firmware file

- Checking firmware file and Sending

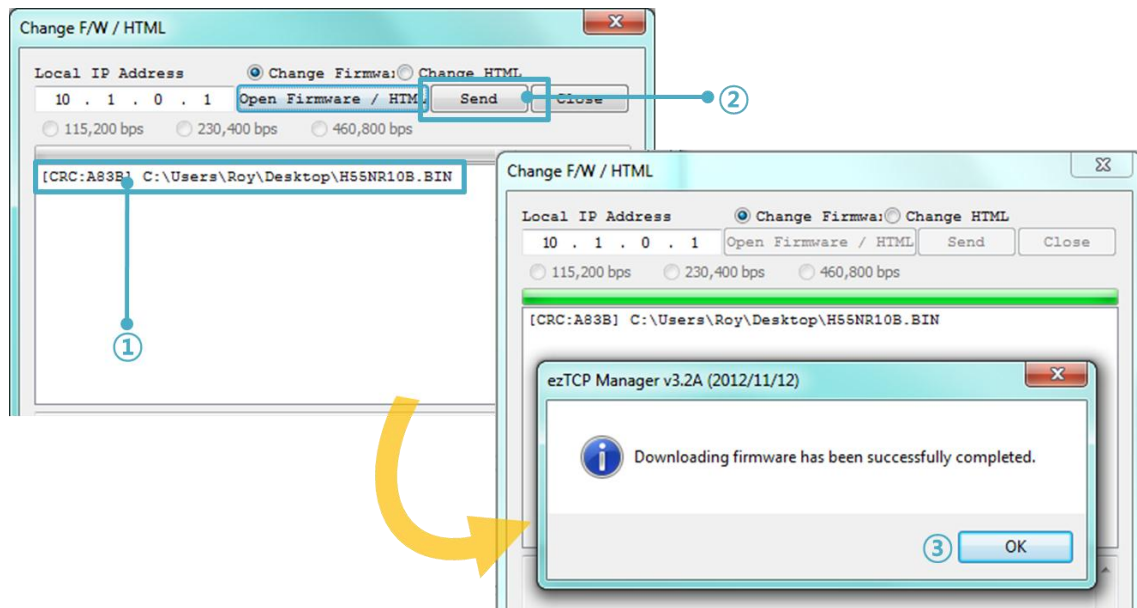

Figure 6-2 sending firmware file

- ① Check if the name and path of the firmware file are correct
- ② Click the [Send] button
- ③ Confirm the completed message

6.2 Status Monitoring

6.2.1 Using TELNET

Once the [TELNET] option is activated, users can remotely log in to CSE-H55N. If a password is set, users should input the password.

After then, messages from CSE-H55N appear like the below figure.

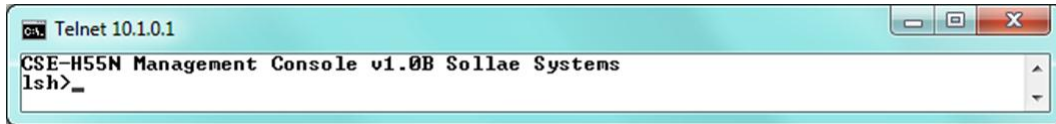

Figure 6-3 log in to CSE-H55N on TELNET

Followed commands let users check each state.

Command	Option	Description	Usage
st	net	IPv4 Network Status	lsh>st net
	net6	IPv6 Network Status	lsh>st net6
	sio	Serial Port Status	lsh>st sio
	uptime	System Uptime	lsh>st uptime
sc	[op1][op2]	Session Control	lsh>sc com1 close

Table 6-1 Commands for checking states

- st net

“st net” command displays present IPv4 network states of all sessions.

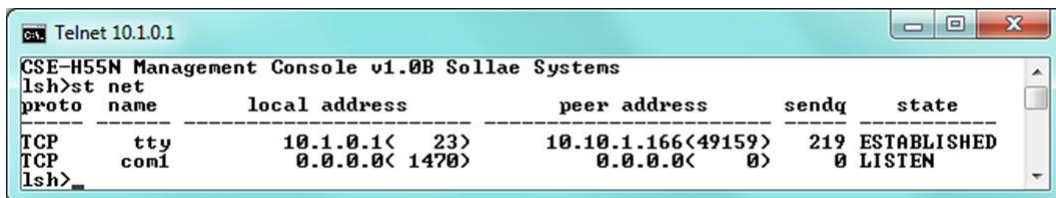

Figure 6-4 “st net command”

- st net6

"st net6" command displays present IPv6 network states of all sessions.

```

CSE-H55N Management Console v1.0B Sollae Systems
lsh>st net6
-----
proto  name                local/peer address          sendq  state
-----
TCP6   tty                  fe80::230:f9ff:fe11:1< 23>  127   ESTABLISHED
                    fe80::70b6:5c45:b180:ea9d<49161>
lsh>

```

Figure 6-5 "st net6 command"

- st sio

"st sio" command displays the number of bytes for the serial port.

```

lsh>st sio
-----
port  fmax  rbmax  rxbuf  txbuf  rx_count  tx_count
-----
com1  0     0     0     0     0         0
lsh>

```

Figure 6-6 "st sio" command

- st uptime

"st uptime" command shows amount of time since CSE-H55N boots up.

```

lsh>st uptime
00:27:26.07 up 0 days
lsh>[20~

```

Figure 6-7 "st uptime" command

- sc

"sc" command is used when users close a session. [op1] means the name of session, and [op2] should be "close".

```

lsh>sc com1 close
com1: closed
lsh>

```

Figure 6-8 "sc" command

☞ *In case of the "sc" command you should use only small letters.*

☞ *You can download TCP Client application for a smartphone on our website.*

6.2.2 Using ezManager

Status of CSE-H55N can be monitored by [Status] button on ezManager. By using the [Refresh Every 1 Second] option in the status window, the status is automatically updated in every second

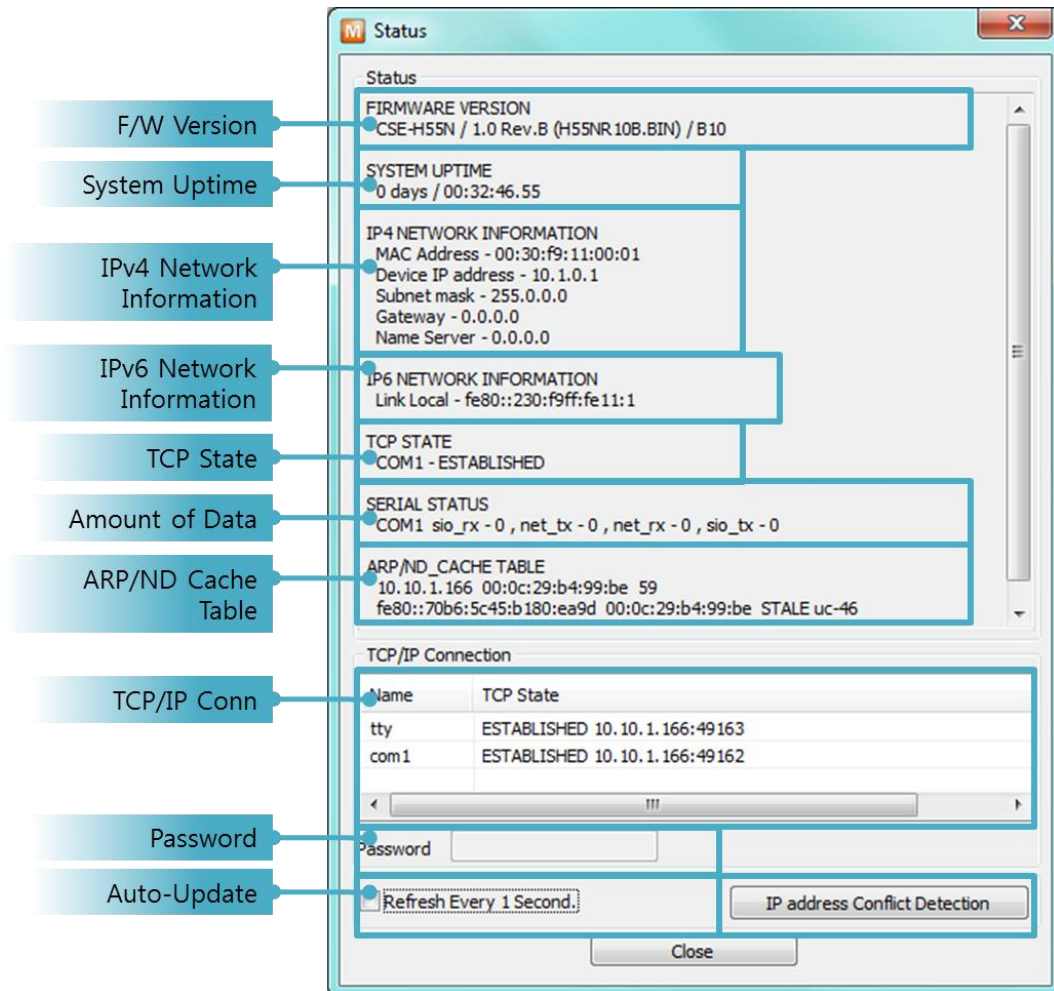

Figure 6-5 status window of ezManager

- **FIRMWARE VERSION**
The name of model name and the version of firmware are displayed here.
- **SYSTEM UPTIME**
Amount of time is displayed since CSE-H55N boots up.
- **IP4 NETWORK INFORMATION**
All information about related items with IPv4 Address is shown here. It works even if the IP address is assigned from DHCP or PPPoE.

- IP6 NETWORK INFORMATION

All information about related items with IPv6 Address is shown here. It works even if the IP address is assigned from DHCP or PPPoE.

- TCP STATE

TCP status of each port is shown this section.

Message	Description
LISTEN	listening TCP connection
CLOSE	TCP connection is closed
SYN_SENT	Send "SYN" segment to make TCP connection
ESTABLISHED	When TCP connection is established
N/A	In UDP mode

Table 6-2 TCP STATE

- SERIAL STATUS

Amount of data in every buffer is displayed. The unit is byte.

Buffer	Description
sio_rx	The number of data which is received from the COM port
net_tx	The number of data which is sent to the remote host
net_rx	The number of data which is received from the remote host
sio_tx	The number of data which is sent to the COM port

Table 6-3 SERIAL STATUS

- ARP/ND CACHE TABLE

This part shows ARP table on CSE-H55N. When TCP connection is established or UDP data communication is performed, the information of IP and MAC address is automatically stored in the ARP table. This information is held for 1 minute. When 50 seconds is passed, CSE-H55N starts broadcasting the ARP packet again. If there is no response until the time is 0, the information is removed. If there is response, the time is updated 60 seconds again.

In IPv6 case, it shows ND cache list. User can check by the ND cache messages. The messages are as follows.

Status	Description
INCOMPLETE	This means the device is standing by after it sends the request message, Neighbor Solicitation, to MAC and link local address of an opponent in the initial communication.
REACHABLE	This means the device has information about the opponent after it sends Neighbor Solicitation, and receives Neighbor Advertisement.
STALE	The device will change into STALE state after some time later reaching REACHABLE.
DELAY	The device will change into DELAY state if there is no response to Neighbor Solicitation. In this case, CSE-H53N will not be able to communicate with the device.
PROBE	CSE-H53N will resend the request message to the device in DELAY state. CSE-H53N will keep sending Neighbor Solicitation until it replies.

- TCP/IP Connection

In this section, the same information with TCP STATE is displayed with IP address and port number. A difference is that users can terminate TCP connection. When right click on a session, a small pop-up window is created.

- Password

This text box is activated when CSE-H55N has a password. If users want to close TCP connection with right click of mouse on the session, this password has to be correctly filled.

- Refresh Every 1 Second.

If this option is checked, ezManager send query in every second.

- IP address Conflict Detection

By clicking this button, you can find devices which have the same IP address to yours on the network.

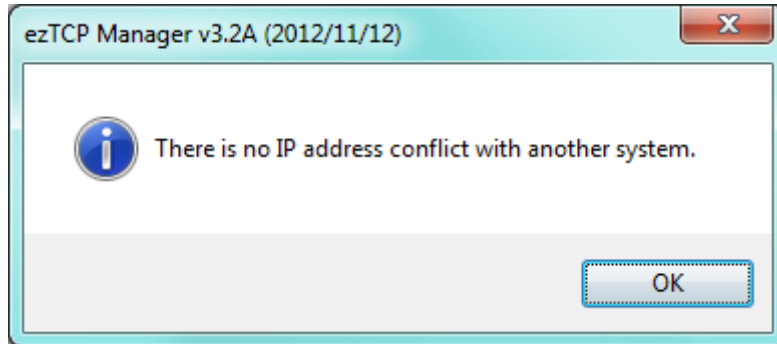

Figure 6-10 Without IP address conflict detection

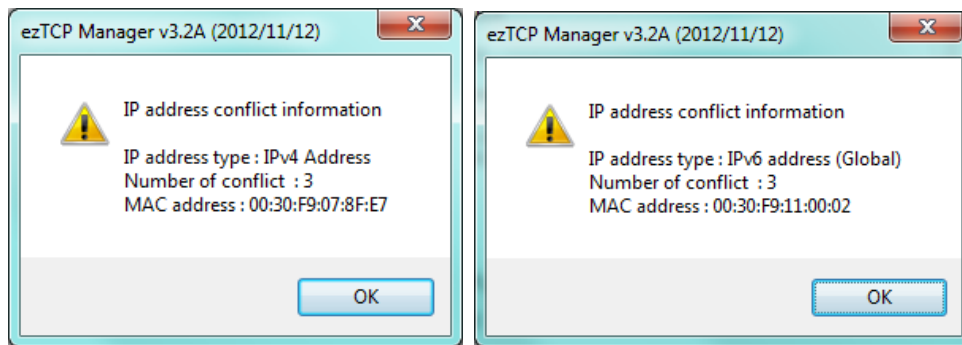

Figure 6-11 IP address conflict detection

6.3 Factory Reset

It is a function physically initializes all the setting. You can save a setting to user-defined ENV region and use it as default values by the factory reset. However, if you do not use the region, Factory Reset uses a factory default by manufacturer as its default values.

6.3.1 Using Factory Reset

- ① Push the function button low 1 second
 - ② Push the function button over 10 seconds
- LED status is as follow pictures.

- STS ON

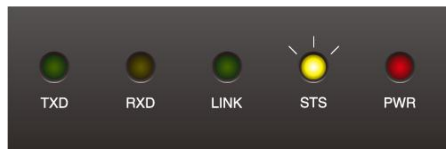

- LINK ON



- RXD ON

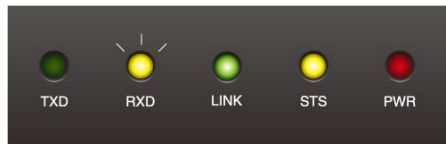

- TXD, RXD, LINK, STS, PWR are ON

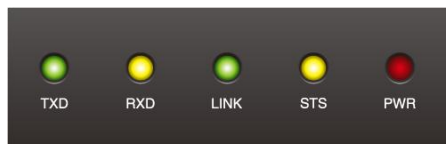

- ③ TXD, RXD, LINK, STS are blinks



6.3.2 Setting custom default values

- ① Change the mode to Serial Configuration
- ② Save custom default values by ezManager or serial configuration commands
- ③ Input the command below

b	<SPACE>	3c5a	<CR>
---	---------	------	------

- ④ After step ③, current values in the SRAM is saved in user-defined ENV region and the values will be always used for Factory Reset.

7 Security Function

7.1 SSL

7.1.1 What is the SSL(Secure Socket Layer)?

SSL is cryptographic protocol that provides secure communication on the Internet. The SSL works over TCP.

7.1.2 How to set the SSL

To works for SSL, you have to set the SSL-related parameters as the following steps. Set the [SSL] check box in the ezManager.

- ① Check the [SSL] of the [Option] tab of the ezManager.

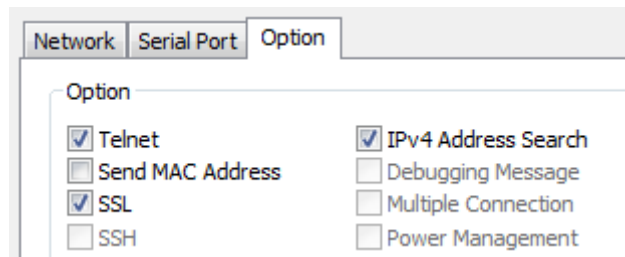

Figure 7-1 Setting of Option

- ② After check the [Advanced Menu] of the ezManager , Click the [Certificate].



Figure 7-2 Create the certification

- ③ Choice the [Write self signed certificate]

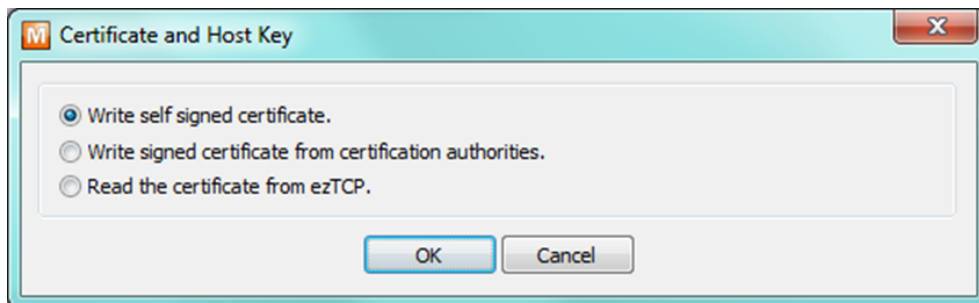

Figure 7-3 Create the RSA Key

- ④ Input the key length and information in [Self signed certificate]

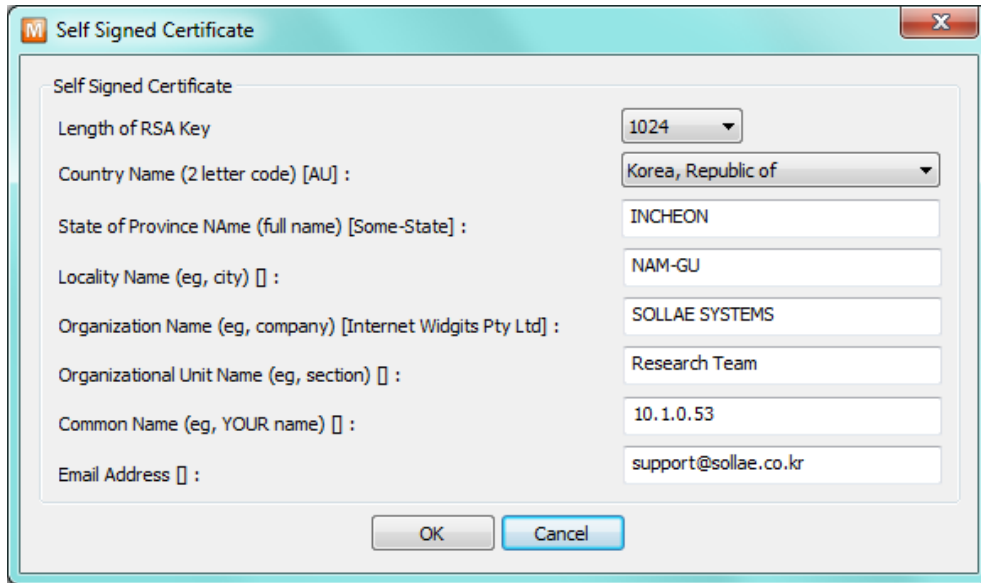

Figure 7-4 Input the information

- ⑤ Check a success message.

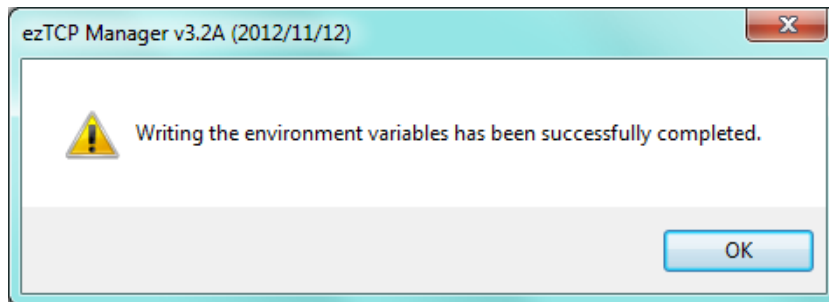

Figure 7-5 Check of success message

7.1.3 Restriction

- If user set the SSL with the CSE-H53N, the other device have to set the SSL.
- Maximum baud rate of serial port is the 115,200bps.
- Cannot use SSL feature in IPv6.

7.2 Access Restriction (ezTCP Firewall)

On the [Option] tab of ezManager, you can set access restriction function with MAC and IP address.

- Allowed MAC Address

If this option has a valid value, the device which has the MAC address is only permitted to access.

- Allowed IP Address

This is for qualifying hosts with IP address or range of IP addresses. The range is defined by multiplying [IP address] and [Network Mask] in bit unit.

- Examples for IPv4

IP Address	Network Mask	Allowed IP Address Range
10.1.0.1	255.0.0.0	10.1.0.1 ~ 10.255.255.254
10.1.0.1	255.255.255.0	10.1.0.1 ~ 10.1.0.254
192.168.1.4	255.255.255.255	192.168.1.4

Table 7-1 examples of defining allowed IPv4 range

- Apply to ezManager

[Apply to ezManager] is for applying above two restrictions to ezManager functions like [Search], [Read], [Write] and etc.

- Examples for IPv6

IPv6 Address	Prefix	Allowed IP Address Range
2001:DB8::100	64	2001:DB8::1 ~ 2001:DB8::FFFF:FFFF:FFFF:FFFF
2001:DB8::100	128	2001:DB8::100

Table 7-2 examples of defining allowed IPv6 range

7.2.1 Setting Password

A password can be used for protecting CSE-H55N from TELNET login or changing environmental parameters by hosts which are not qualified. The maximum length is 8 bytes of Alphabet or number.

☞ ***When you want to revoke all of these restrictions, operate CSE-H55N as ISP mode. In the mode, all restrictions are removable and communication with ezManager is revoked.***

8 Additional Functions

8.1 Notify IPv4 Change

CSE-H55N can be TCP server even though it assigned IP address automatically. Using [Notify IP Change] function, CSE-H55N sends its IP address with the host name to the designed server. There are 3 types- DDNS, TCP and UDP- for this service.

- Dynamic Domain Name Service (DDNS)

CSE-H55N supports DDNS service offered by DynDNS. Therefore, you have to make an account and create host names on the website of DynDNS before you use.

- ☞ *All about service usage of an account could be changed according to the policy of DynDNS.*
- ☞ *DynDNS website: <http://dyn.com/dns/>*

Figure 8-1 setting DDNS

- ① Select the [DDNS(dyndns.org)]
- ② 40,320 is a fixed value
- ③ Input the ID of DDNS account
- ④ Input the password of the account
- ⑤ Input a host name which you create on your account

- TCP/UDP

In case you have an own server and want to manage the information about changed IP addresses, you allowed used TCP/UDP for using this option. The [Data Type] can be ASCII or hexadecimal, and the [Interval] is available on configuration.

- ☞ *Refer to the [IP Change Notification] document on our website for details.*

8.2 Sending MAC Address

[Sending MAC Address] is a function that CSE-H55N sends its MAC address to the remote host right after the connection is established. By using this function, a server can identify multiple devices with the information.

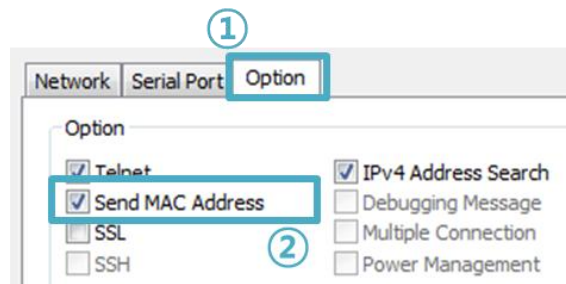

Figure 8-2 setting of Sending MAC Address function

- ① Move to the [Option] tab.
- ② Check the [Send MAC Address] option.

☞ ***You can use [Send MAC Address] and [SSL] at the same time.***

☞ ***Refer to the [Sending MAC Address Function] document on our website for details.***

8.3 Serial Port Tab Functions

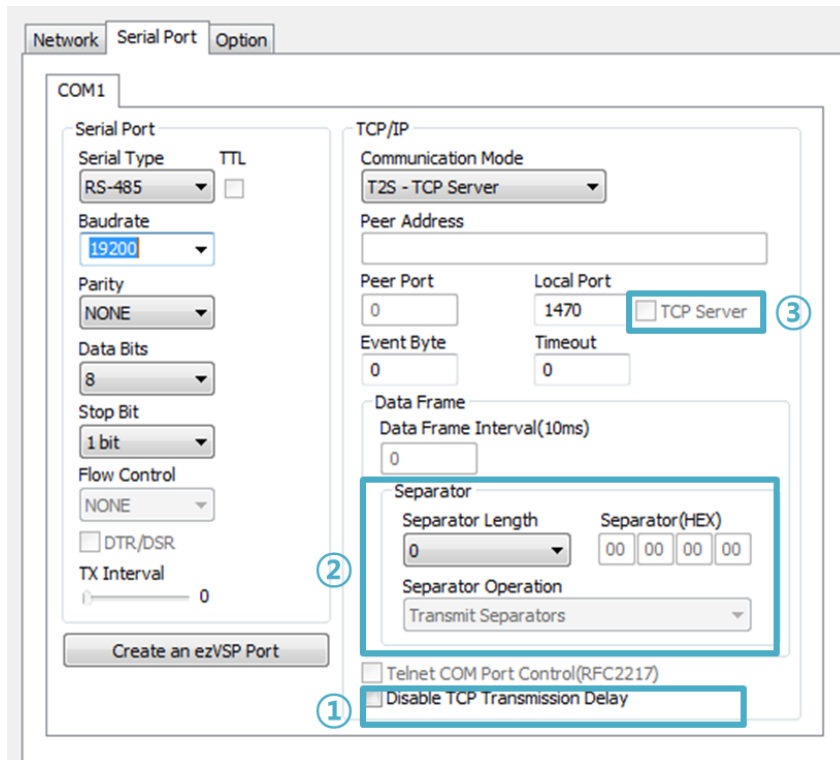

Figure 8-3 setting of Serial port tab functions

8.3.1 Disable TCP Transmission Delay - ①

If you use this option, CSE-H55N sends the data from the serial port to LAN as quickly as possible.

8.3.2 Separator - ②

Using this function, you can control the length of network packets by specific characters.

separator	options
Length	select the length between 0 ~ 4 bytes
Operation	Transmit Separators without additional bytes
	Transmit Separators + 1 byte
	Transmit Separators + 2 bytes

Table 8-1 separator

8.3.3 TCP Server / Client mode - ③

This mode is available on TCP client mode only. In this mode, you do not need to change the mode for switching active or passive TCP connection. Note that the [Event Byte] option should be set to more than 1.

☞ *Refer to the [TCP Server / Client mode] document on our website for details.*

☞ *CSE-H55N's Data Frame interval is configured 2byte data interval. Before sending data from the serial port to LAN, CSE-M53N gathers data in the buffer. If there is no data during the time configured in the 2byte data interval, it will send data to the network.*

9 RS485/RS422 Interface

9.1 About RS485/RS422 Network

The RS485 and the RS422 are the standards which communicate by differential voltage. These transmission distances are much longer comparing to the RS232. The RS485 is multi-driver/multi-receiver system but the RS422 is a single-driver/multi-receiver system.

9.2 Configuring an RS485 Network

The following is a general RS485 diagram.

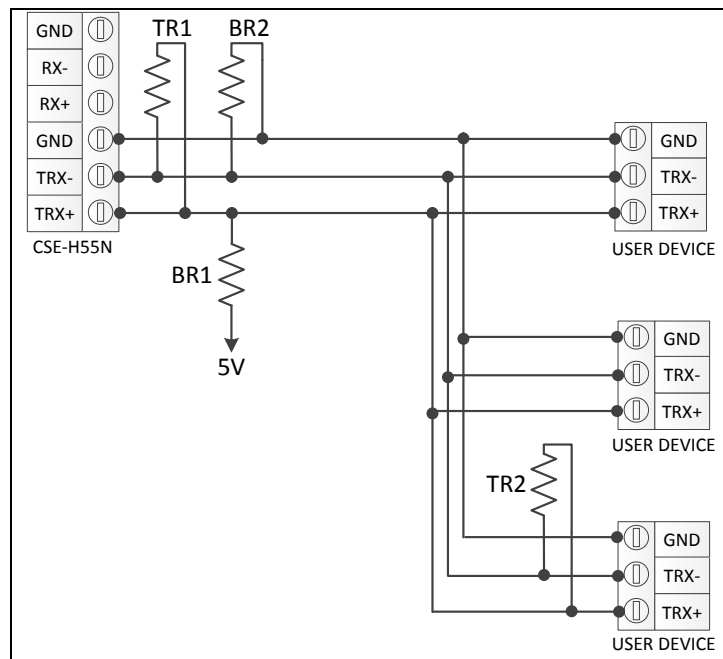

Figure 9-1 General RS485 Network

9.2.1 Signal Ground

Even though the RS485 is known as a "two-wire" configuration, an additional ground connection should be implemented.

If a signal ground is not used, there might be potential differences between nodes. And it could be electrical noise or damages the transceivers.

9.2.2 Biasing Resistors

Two biasing resistors (a pull-up resistor and a pull-down resistor) should be in the RS485

network to make differential voltage within the standard. (BR1 and BR2 are biasing resistors in the above picture)

In normal case, RS485 line drivers don't require any biasing resistors, but it makes some problems in some cases.

Generally 680 ohm resistors are used for the biasing resistors. If the biasing resistor is higher, power consumption is lower but delay is longer. And if the biasing resistor is lower, delay might is shorter but power consumption will be higher.

9.2.3 Termination Resistors

There should be two termination resistors in the ends of transmission line to prevent reflection waves when the cable is long or communication speed is fast. (TR1 and TR2 are termination resistors in the above picture.)

The resistors' resistance should be same to cable's characteristic impedance. Normal cable's characteristic impedance is 100 ohm or 120 ohm.

9.3 Configuring an RS422 Network

9.3.1 1:1 Configuration

The following is 1:1 configuration of RS422.

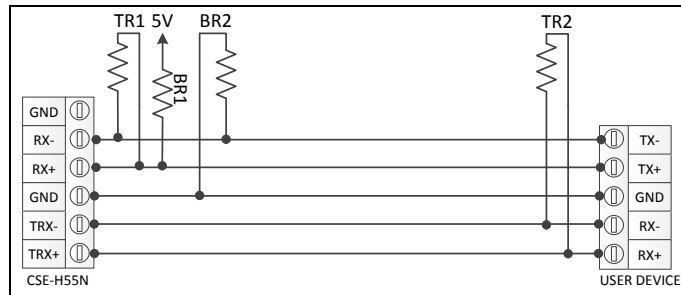

Figure 9-2 RS422 1:1 Configuration

9.3.2 1:N Configuration

The following is 1:N configuration of RS422.

When the CSE-H55N operates as RS422 mode, it can't be a slave because its driver is driving always.

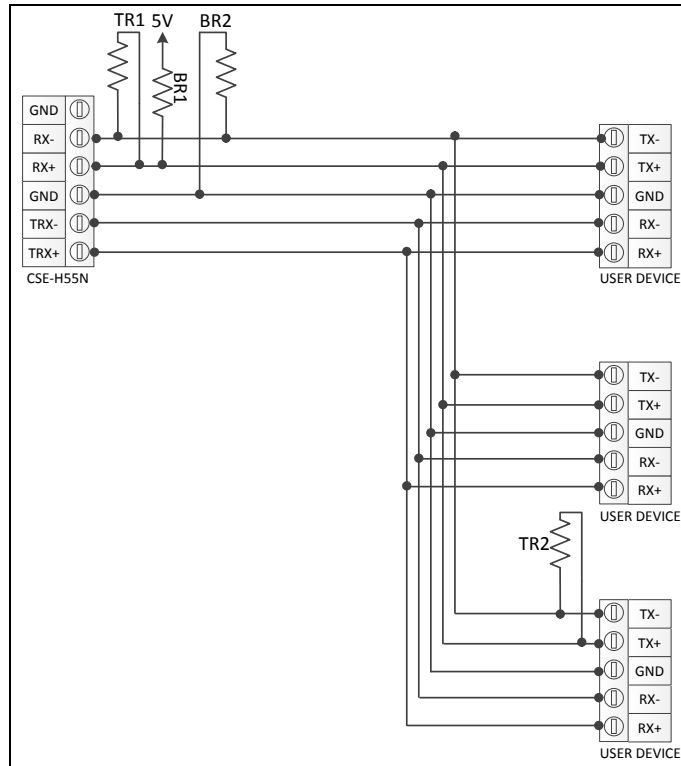

Figure 9-3 RS422 1:N Configuration

9.3.3 Signal Ground, Biasing and Termination Resistors

Like RS485, the RS422 requires signal ground connections, biasing resistors and termination resistors.

Please refer to the RS485 section for more information.

10 Checklist in Trouble

When users are in trouble with CSE-H55N, make sure all the followed steps first.

10.1 Searching problem with ezManager

- Confirming types of configuration utility
CSE-H55N can be configured by ezManager.
- Stopping Firewall operation
Firewalls of personal computer or network block broadcast packets. Stop all the firewalls before searching CSE-H55N

☞ ***Most of vaccine programs have firewall functions so it can cause some trouble to search CSE-H55N. Stop these programs before the searching.***

- Stable supply of the power
Check if the power is supplied continually. If the power is constantly supplied, the PWR (Red) LED on the CSE-H55N's body will be turned ON.
- Connection with the network
Make sure that the network connection is fine including Ethernet cable. In this step, we recommend that users connect CSE-H55N with PC directly or in the same network hub.
- Checking options of restriction
In case that restriction of access is activated, the communication with ezManager can be impossible. When users are in this situation, make CSE-H55N operate in ISP mode.

10.2 Connection Problem over TCP/IP

- Checking parameters related with TCP/IP

When CSE-H55N has a private network IP address, personal computer's IP address has to be the same sub network. Check if the IP address and local port number are correct. In case of a fixed IP address, the subnet mask, gateway IP address and DNS IP address should be configured.

TCP Server side	TCP Client side
Local IP Address, Local Port, Subnet Mask, Gateway IP Address, DNS IP Address, DDNS	Local IP Address, Peer Address, Peer Port, Subnet Mask, Gateway IP Address, DNS IP Address,

Table 10-1 major parameters related with TCP/IP

- PING Test

Confirm the connection over the network by PING test. If the CSE-H55N doesn't send any reply from the request, check the network environment.

- Firewall

In case the networks which need strong security, the access may be denied by their firewall. Under this circumstance, users should ask the person in charge of their network to release ports which will be used. (Ex: TCP 1470, UDP 50005)

- Operation Mode

TCP connection is not possible when CSE-H55N is operating in the ISP or Serial Configuration mode.

- Communication Mode

To make TCP connection, both a server and client should exist. If there are only servers or clients, TCP connection can't be established.

- ezTCP Firewall

When users set the ezTCP firewall with MAC and IP address, any hosts can't be reachable to it except for the hosts which have the allowed MAC and IP address. Inactivate the option or check the setting is correct.

- Checking the TCP status

TCP is a protocol connected one to one without multiple connection function. Because of this, if a device is on TCP connection, other requests are denied. If users are in this situation, check the network status by connecting on TELNET or using ezManager.

10.3 Data Communication Problem over the Serial Port

- Connection of Pins

Check if the connection of each pin is right. Using cables, users choose the right type of cable which is suitable for the device. Each pin should be connected with the same polarity like the below figures.

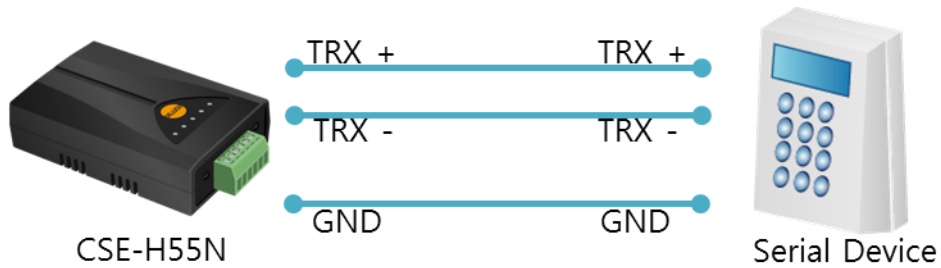

Figure 10-1 RS485 connection

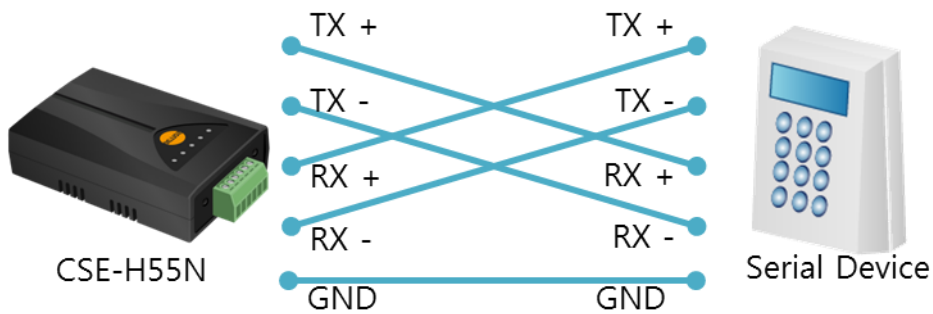

Figure 10-2 RS422 connection

☞ ***You must connect the Ground pin to your device when using RS422 or RS485 as well as RS232.***

- Setting parameters

Check if all the serial port parameters like Baud Rate, Data bit, Stop bit and Parity are properly set.

☞ ***Contact us if you have any questions about above steps or our products.***

11 Related Material

11.1 Technical Documents

You can find the technical documents at our website.

- DataSheet
- IP Change Notification(DDNS)
- Sending MAC Address function
- TCP Server/Client mode
- Etc

11.2 Smart phone Application

- ezManager(IOS)
- ezManager(Android)
- TCP/IP Client(Android)

12 Technical Support and Warranty

12.1 Technical Support

If you have any question regarding operation of the product, visit Customer Support FAQ corner and the message board on Sollae Systems' web site or send us an email at the following address:

- E-mail: support@eztcp.com
- Website Address for Customer Support: <http://www.eztcp.com/en/support/>

12.2 Warranty

12.2.1 Refund

Upon the customer's request to refund the product within two weeks after purchase, Sollae Systems will refund the product.

12.2.2 Free Repair Services

For product failures occurring within 2 years after purchase, Sollae Systems provides free repair services or exchange the product. However, if the product failure is due to user's fault, repair service fees will be charged or the product will be replaced at user's expense.

12.2.3 Charged Repair Services

For product failures occurring after the warranty period (2 years) or resulting from user's fault, repair service fees will be charged and the product will be replaced at user's expense.

13 Precaution and Exemption from Liability

13.1 Precaution

- Sollae Systems is not responsible for product failures occurring due to user's alternation of the product.
- Specifications of the product are subject to change without prior notice for performance improvement.
- Sollae Systems does not guarantee successful operation of the product if the product was used under conditions deviating from the product specifications.
- Reverse engineering of firmware and applications provided by Sollae Systems is prohibited.
- Use of firmware and applications provided by Sollae Systems for purposes other than those for which they were designed is prohibited.
- Do not use the product in an extremely cold or hot place or in a place where vibration is severe.
- Do not use the product in an environment in which humidity is high or a lot of oil exists.
- Do not use the product where there is caustic or combustible gas.
- Sollae Systems does not guarantee normal operation of the product under the conditions a lot of noise exists.
- Do not use the product for a purpose that requires exceptional quality and reliability relating to user's injuries or accidents – aerospace, aviation, health care, nuclear power, transportation, and safety purposes.
- Sollae Systems is not responsible for any accident or damage occurring while using the product.

13.2 Exemption from Liability

13.2.1 English version

In no event shall Sollae Systems Co., Ltd. and its distributors be liable for any damages whatsoever (including, without limitation, damages for loss of profit, operating cost for commercial interruption, loss of information, or any other financial loss) from the use or inability to use the CSE-H55N even if Sollae Systems Co., Ltd. or its distributors have been informed of such damages.

The CSE-H55N is not designed and not authorized for use in military applications, in nuclear applications, in airport applications or for use in applications involving explosives, or in medical applications, or for use in security alarm, or for use in a fire alarm, or in applications involving elevators, or in embedded applications in vehicles such as but not limited to cars, planes, trucks, boats, aircraft, helicopters, etc..

In the same way, the CSE-H55N is not designed, or intended, or authorized to test, develop, or be built into applications where failure could create a dangerous situation that may result in financial losses, damage to property, personal injury, or the death of people or animals. If you use the CSE-H55N voluntarily or involuntarily for such unauthorized applications, you agree to subtract Sollae Systems Co., Ltd. and its distributors from all liability for any claim for compensation.

Sollae Systems Co., Ltd. and its distributors entire liability and your exclusive remedy shall be Sollae Systems Co., Ltd. and its distributors option for the return of the price paid for, or repair, or replacement of the CSE-H55N.

Sollae Systems Co., Ltd. and its distributors disclaim all other warranties, either expressed or implied, including, but not limited to, the implied warranties of merchantability and fitness for a particular purpose, with respect to the CSE-H55N including accompanying written material, hardware and firmware.

13.2.2 French version

- Documentation

La documentation du boîtier CSE-H55N est conçue avec la plus grande attention. Tous les efforts ont été mis en œuvre pour éviter les anomalies. Toutefois, nous ne pouvons garantir que cette documentation soit à 100% exempt de toute erreur. Les informations présentes dans cette documentation sont données à titre indicatif. Les caractéristiques techniques peuvent changer à tout moment sans aucun préavis dans le but d'améliorer la qualité et les possibilités des produits.

- Copyright et appellations commerciales

Toutes les marques, les procédés, les références et les appellations commerciales des produits cités dans la documentation appartiennent à leur propriétaire et Fabricant respectif.

- Conditions d'utilisations et limite de responsabilité

En aucun cas Sollae Systems Co., Ltd ou un de ses distributeurs ne pourra être tenu responsable de dommages quels qu'ils soient (intégrant, mais sans limitation, les dommages pour perte de bénéfice commercial, interruption d'exploitation commerciale, perte d'informations et de données à caractère commercial ou de toute autre perte financière) provenant de l'utilisation ou de l'incapacité à pouvoir utiliser le boîtier CSE-H55N, même si Sollae Systems Co., Ltd ou un de ses distributeurs a été informé de la possibilité de tels dommages.

Le boîtier CSE-H55N est exclusivement prévu pour un usage en intérieur, dans un environnement sec, tempéré (+10 °C à +40°C) et non poussiéreux. Le boîtier CSE-H55N n'est pas prévu, ni autorisé pour être utilisé en extérieur, ni de façon embarquée dans des engins mobiles de quelque nature que ce soit (voiture, camion, train, avion, etc...), ni en milieu explosif, ni dans des enceintes nucléaires, ni dans des ascenseurs, ni dans des aéroports, ni dans des enceintes hospitaliers, ni pour des applications à caractère médical, ni dans des dispositifs de détection et d'alerte anti-intrusion, ni dans des dispositifs de détection et d'alerte anti-incendie, ni dans des dispositifs d'alarme GTC, ni pour des applications militaires.

De même, le boîtier CSE-H55N n'est pas conçu, ni destiné, ni autorisé pour expérimenter, développer ou être intégré au sein d'applications dans lesquelles une défaillance de celui-ci pourrait créer une situation dangereuse pouvant entraîner des pertes financières, des

dégâts matériel, des blessures corporelles ou la mort de personnes ou d'animaux. Si vous utilisez le boîtier CSE-H55N volontairement ou involontairement pour de telles applications non autorisées, vous vous engagez à soustraire Sollae Systems Co., Ltd et ses distributeurs de toute responsabilité et de toute demande de dédommagement.

En cas de litige, l'entière responsabilité de Sollae Systems Co., Ltd et de ses distributeurs vis-à-vis de votre recours durant la période de garantie se limitera exclusivement selon le choix de Sollae Systems Co., Ltd et de ses distributeurs au remboursement de votre produit ou de sa réparation ou de son échange. Sollae Systems Co., Ltd et ses distributeurs démentent toutes autres garanties, exprimées ou implicites.

Tous les boîtiers CSE-H55N sont testés avant expédition. Toute utilisation en dehors des spécifications et limites indiquées dans cette documentation ainsi que les court-circuit, les chocs, les utilisations non autorisées, pourront affecter la fiabilité, créer des dysfonctionnements et/ou la destruction du boîtier CSE-H55N sans que la responsabilité de Sollae Systems Co., Ltd et de ses distributeurs ne puissent être mise en cause, ni que le boîtier CSE-H55N puisse être échangé au titre de la garantie.

- Rappel sur l'évacuation des équipements électroniques usagés

Le symbole de la poubelle barré présent sur le boîtier CSE-H55N indique que vous ne pouvez pas vous débarrasser de ce dernier de la même façon que vos déchets courants. Au contraire, vous êtes responsable de l'évacuation du boîtier CSE-H55N lorsqu'il arrive en fin de vie (ou qu'il est hors d'usage) et à cet effet, vous êtes tenu de le remettre à un point de collecte agréé pour le recyclage des équipements électriques et électroniques usagés. Le tri, l'évacuation et le recyclage séparés de vos équipements usagés permettent de préserver les ressources naturelles et de s'assurer que ces équipements sont recyclés dans le respect de la santé humaine et de l'environnement. Pour plus d'informations sur les lieux de collecte des équipements électroniques usagés, contacter votre mairie ou votre service local de traitement des déchets.

14 Revision History

Date	Version	Comments	Author
2012.11.16	1.0	○ First version has been released.	Lisa Shin
2012.12.13	1.1	○ Change the capture files	Lisa Shin
2013.01.11	1.2	○ Add descriptions of 422/485 Interface ○ Add caution of saving on the ISP mode	Lisa Shin
2013.02.27	1.3	○ Add and modify some descriptions about connecting ground pins	Lisa Shin
2013.05.08	1.4	○ Delete descriptions of data frame option ○ Add related material contents	Lisa Shin
2013.05.15	1.5	○ Add Exemption from Liability contents ○ Add Related Material contents ○ Modify some expressions	Lisa Shin