

8ports Remote I/O Controller

# CIE-H10 User Manual

Version 3.5



Sollae Systems Co., Ltd.

<http://www.ezTCP.com>



This symbol, found on your product or on its packaging, indicates that this product should not be treated as household waste when you wish to dispose of it. Instead, it should be handed over to an applicable collection point for the recycling of electrical and electronic equipment. By ensuring this product is disposed of correctly, you will help prevent potential negative consequences to the environment and human health, which could otherwise be caused by inappropriate disposal of this product. The recycling of materials will help to conserve natural resources. For more detailed information about the recycling of this product, please contact your local city office, household waste disposal service or the retail store where you purchased this product.

※ This equipment obtained certification by using 1.5M serial cable.

# Contents

<b>Contents</b> .....	<b>- 2 -</b>
<b>1 Introduction</b> .....	<b>- 6 -</b>
1.1 Introduction .....	- 6 -
1.2 Features .....	- 6 -
1.3 Application Examples .....	- 7 -
1.4 Components.....	- 9 -
1.5 Specification .....	- 10 -
1.5.1 H/W specification .....	- 10 -
1.5.2 S/W specification .....	- 10 -
1.6 Interface .....	- 11 -
1.6.1 Input Ports .....	- 11 -
1.6.2 Output Ports .....	- 12 -
1.6.3 RS232 Port (DB9M).....	- 13 -
1.6.4 Ethernet Interface.....	- 14 -
1.6.5 Power.....	- 14 -
1.6.6 System LED.....	- 15 -
1.6.7 ISP Switch.....	- 16 -
<b>2 Installation and Test</b> .....	<b>- 17 -</b>
2.1 Installation .....	- 17 -
2.1.1 Setting Network Aera .....	- 17 -
2.2 Test operation.....	- 19 -
2.2.1 Modbus/TCP Test.....	- 19 -
2.2.2 HTTP Test with a WEB browser.....	- 21 -
<b>3 Configuration</b> .....	<b>- 22 -</b>
3.1 Configuration with ezManager.....	- 22 -
3.1.1 Configuration via LAN.....	- 22 -
3.1.2 Configuration via Serial .....	- 23 -
3.2 AT command.....	- 24 -
<b>4 Operation Modes</b> .....	<b>- 25 -</b>
4.1 What is the Operation Mode?.....	- 25 -
4.2 How to change the mode to another .....	- 25 -
4.3 Comparison of the each mode .....	- 26 -
4.4 Normal Mode .....	- 26 -

4.5	Serial Configuration mode .....	- 27 -
4.5.1	Configuring Parameters.....	- 27 -
4.5.2	Revoking Security Options.....	- 27 -
4.6	ISP mode.....	- 28 -
4.6.1	Upgrading Firmware.....	- 28 -
4.6.2	Upgrading HTML.....	- 28 -
4.6.3	Revoking Security Options.....	- 28 -
<b>5</b>	<b>Methods for I/O control .....</b>	<b>- 29 -</b>
5.1	MODBUS/TCP .....	- 29 -
5.1.1	Related Parameters.....	- 29 -
5.1.2	Modbus/TCP Slave Mode.....	- 30 -
5.1.3	Modbus/TCP Master Mode.....	- 30 -
5.1.4	TCP Connection Modes.....	- 31 -
5.1.5	Initial Output Value.....	- 31 -
5.1.6	Write Pulse.....	- 31 -
5.2	Serialized Modbus/TCP .....	- 31 -
5.3	Macro Mode.....	- 32 -
5.3.1	Operator.....	- 32 -
5.3.2	Operand.....	- 32 -
5.3.3	An Example of Equations.....	- 33 -
5.4	Web (HTTP).....	- 34 -
5.4.1	Changing port number for HTTP.....	- 34 -
5.4.2	Uploading Users' Web Page.....	- 35 -
<b>6</b>	<b>Communication Modes .....</b>	<b>- 36 -</b>
6.1	TCP Server .....	- 36 -
6.1.1	Key parameters.....	- 36 -
6.1.2	An Example.....	- 37 -
6.2	TCP Client .....	- 38 -
6.2.1	Key parameters.....	- 38 -
6.2.2	An Example.....	- 39 -
6.3	AT Command .....	- 41 -
6.3.1	Key parameters.....	- 41 -
6.3.2	Examples.....	- 42 -
6.4	UDP .....	- 44 -
6.4.1	Key parameters.....	- 44 -
6.4.2	Examples.....	- 45 -

- 7 System Management..... - 47 -**
  - 7.1 Upgrading Firmware..... - 47 -
    - 7.1.1 Firmware..... - 47 -
    - 7.1.2 Processes..... - 47 -
  - 7.2 Changing Webpage..... - 49 -
    - 7.2.1 Webpage..... - 49 -
    - 7.2.2 Processes..... - 49 -
  - 7.3 Status Monitoring..... - 52 -
    - 7.3.1 Using TELNET..... - 52 -
    - 7.3.2 Using ezManager..... - 54 -
- 8 Additional Functions..... - 56 -**
  - 8.1 Security..... - 56 -
    - 8.1.1 Restriction of Access (ezTCP Firewall)..... - 56 -
    - 8.1.2 Setting Password..... - 56 -
  - 8.2 Option Tab Functions..... - 57 -
    - 8.2.1 Notify IP Change..... - 57 -
    - 8.2.2 Sending MAC Address..... - 58 -
    - 8.2.3 Debugging Message..... - 58 -
  - 8.3 Serial Port Tab Functions..... - 60 -
    - 8.3.1 TELNET COM port Control Option (RFC 2217) - ①..... - 60 -
    - 8.3.2 Disable TCP Transmission Delay - ②..... - 60 -
    - 8.3.3 Data Frame Interval - ③..... - 60 -
    - 8.3.4 TX interval - ④..... - 61 -
    - 8.3.5 TCP Server / Client mode - ⑤..... - 61 -
    - 8.3.6 Separator - ⑥..... - 61 -
  - 8.4 Digital I/O Functions..... - 62 -
    - 8.4.1 Valid Time..... - 62 -
    - 8.4.2 Delay..... - 62 -
- 9 Self-Test in Trouble ..... - 63 -**
  - 9.1 Searching problem with ezManager..... - 63 -
  - 9.2 Connection Problem over Modbus/TCP..... - 64 -
  - 9.3 Communication Problem over Modbus/TCP..... - 65 -
- 10 Related material..... - 66 -**
  - 10.1 Technical Documents..... - 66 -
  - 10.2 Smart phone application..... - 66 -

- 11 Technical Support and Warranty ..... - 67 -**
  - 11.1 Technical Support ..... - 67 -
  - 11.2 Warranty..... - 67 -
    - 11.2.1 Refund..... - 67 -*
    - 11.2.2 Free Repair Services ..... - 67 -*
    - 11.2.3 Charged Repair Services..... - 67 -*
  
- 12 Precaution and Exemption from Liability ..... - 68 -**
  - 12.1 Precaution..... - 68 -
  - 12.2 Exemption from Liability..... - 69 -
    - 12.2.1 English version ..... - 69 -*
    - 12.2.2 French version..... - 69 -*
  
- 13 History ..... - 72 -**

# 1 Introduction

## 1.1 Introduction

In the era of Ubiquitous Environment, many kinds of systems which use sensors like temperature, humidity or pressure and controlling the power of remote devices have been developing. CIE-H10 monitors those sensors and controls the remote devices. It detects digital inputs from the sensor's outputs and controls the relay outputs. HTTP, Modbus/TCP, serialized Modbus/TCP and Macro mode can be used for these functions. CIE-H10 is additionally equipped with a RS232 serial interface to allow your serial devices to establish an Ethernet networking connection so that it can be flexibly used in diverse applications.

## 1.2 Features

- Remote I/O controller
- 8 Digital Input Ports (photo-coupler interface)
- 8 Digital Output Ports (relay interface)
- Supports Modbus/TCP and HTTP
- Stored Web server for simple management (custom web page)
- MACRO (stand-alone operation supports simple logical expressions)
- Stable embedded TCP/IP stack
- Easy configuration program (ezManager)

### 1.3 Application Examples

- Remote I/O device server

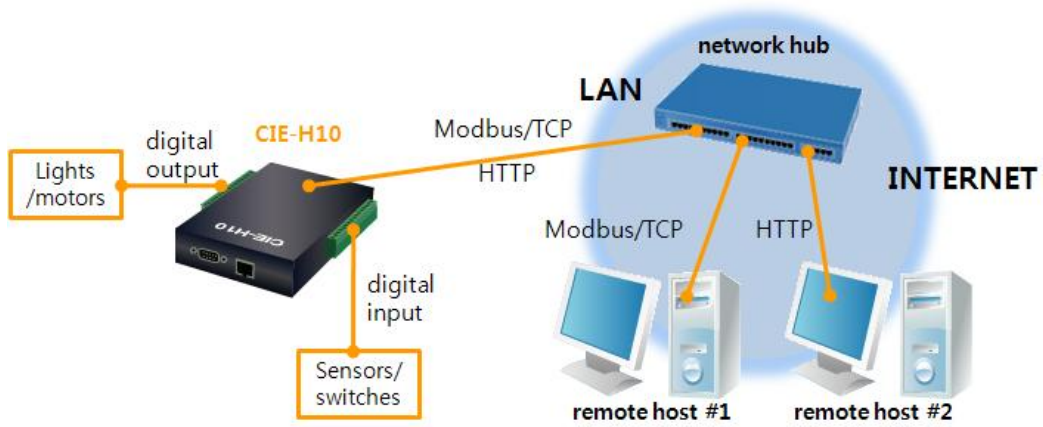

Figure 1-1 remote I/O device server

- Serialized Modbus/TCP

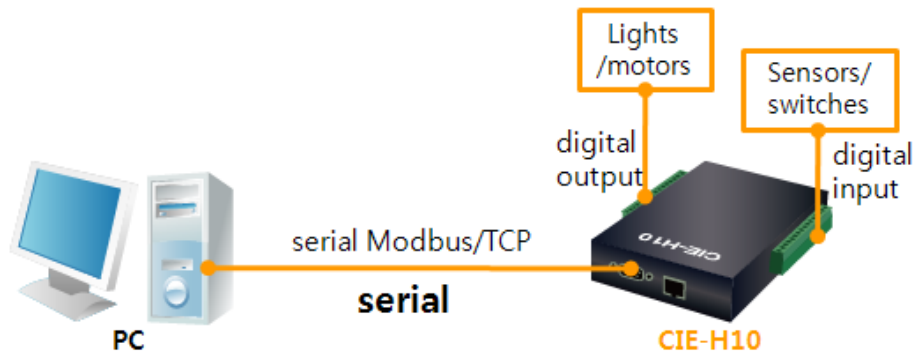

Figure 1-2 serialized Modbus/TCP

- Internet Switch

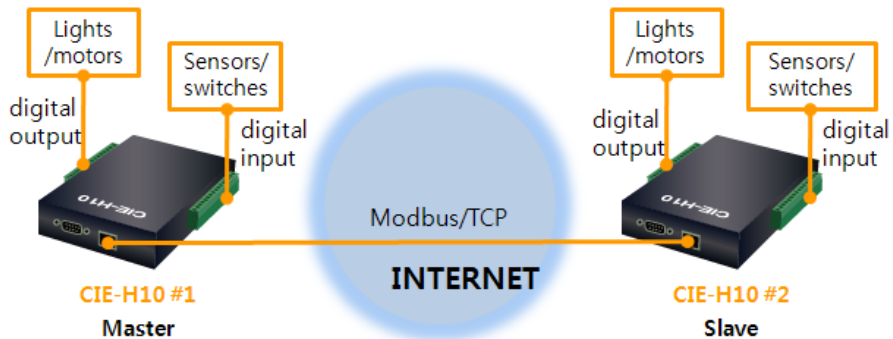

Figure 1-3 internet switch



- Serial Switch

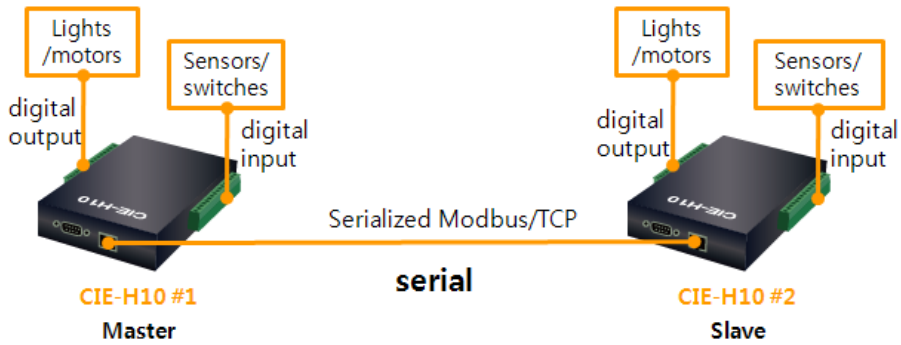

Figure 1-4 serial switch

- Macro mode

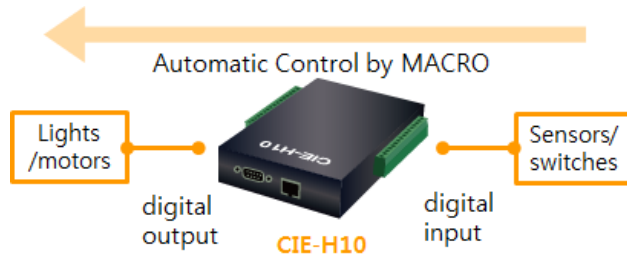

Figure 1-5 macro mode

- Serial Device Server

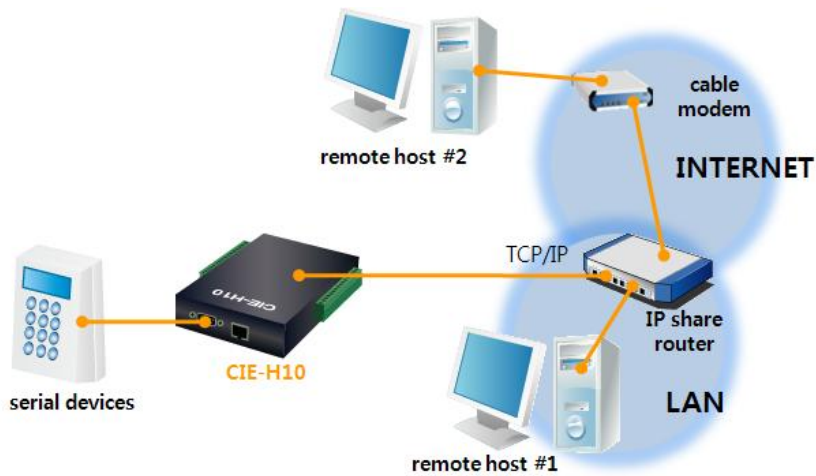

Figure 1-6 serial device server

## 1.4 Components

- CIE-H10
- 5V Power Adapter (optional)
- RS232C Cable for PC (optional)
- Adapter for DIN rail (optional)
- Dry Contact Adapter (optional)

## 1.5 Specification

### 1.5.1 H/W specification

Power	Input Power	5V ( $\pm 10\%$ )
	Current Consumption	510mA typical
Size	153mm x 126mm x 32mm	
Weight	Approximately 530g	
Interfaces	Digital Input	8 ports with photo couplers
	Digital Output	8 ports with relays
	Serial Port	DSUB 9 pins male
	Ethernet	RJ45
Network	Ethernet 10Base-T or 100Base-TX (Auto-Sensing) Auto MDI/MDIX(Cable Auto-sensing)	
Temperature	Operate: 0 ~ 55°C / Storage: -40 ~ 85°C	
Certification	KC, CE	
Environment	Follows Europe RoHS Directive	

Table 1-1 H/W specification

### 1.5.2 S/W specification

Protocol	TCP, UDP, IP, ICMP, ARP, DHCP, DNS lookup, DDNS, Modbus/TCP, HTTP, Telnet COM Port Control Option(RFC2217)	
Diagnose	Online Debugging Function	
Operation mode	Normal	Normal communication mode
	ISP	F/W upgrade
	Serial Configuration	Configuration with the RS232 port
Communication Mode	I/O server	Modbus/TCP – Slave/Master, Passive/Active Web Browser(HTTP), Macro(Stand-alone), Serialized Modbus/TCP
	Serial devices server	TCP Server/Client, AT emulation, UDP
Programs	ezManager	Configuration program via LAN
	ModMap	Modbus/TCP Application for Windows

Table 1-2 S/W specification

## 1.6 Interface

### 1.6.1 Input Ports

Because each of CIE-H10's input ports are isolated by photo-couplers, users don't need to be worried about the polarity. The circuit of the input port is shown in the figure below.

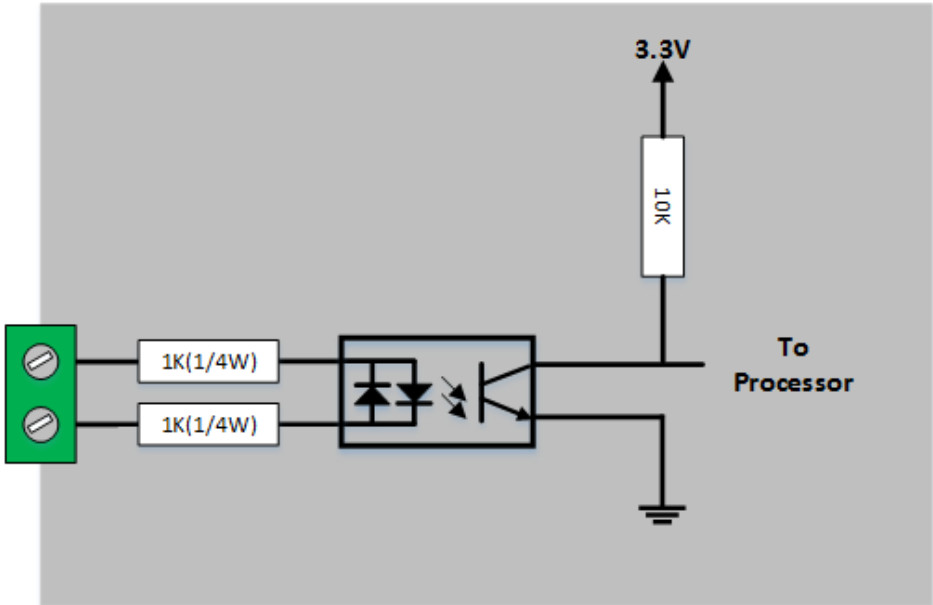

Figure 1-7 a circuit of the input port

The voltage specification of the input port is as follows:

Over 1.8V	H	1
Under 1.2V	L	0
Max. Input Voltage	24V	
Polarity	Auto Polarity	

Table 1-3 the voltage specification of the input ports

The input port is interfaced with a 5mm terminal block. Thus, use a (-) shaped screwdriver to connect it with the user device.

- Types for giving input  
The type of the input ports is a wet contact by photo-couplers, which needs two wires with different voltage levels to make an input signal. Needed a dry contact, you are allowed to use a DCA(Dry Contact Adapter) so that you can give an input signal (ON or HIGH) with switch (relay) interface.

*The input ports are designed only for monitoring signals.*

### 1.6.2 Output Ports

The output ports of CIE-H10 are interfaced to relays (Normal Open) as shown below.

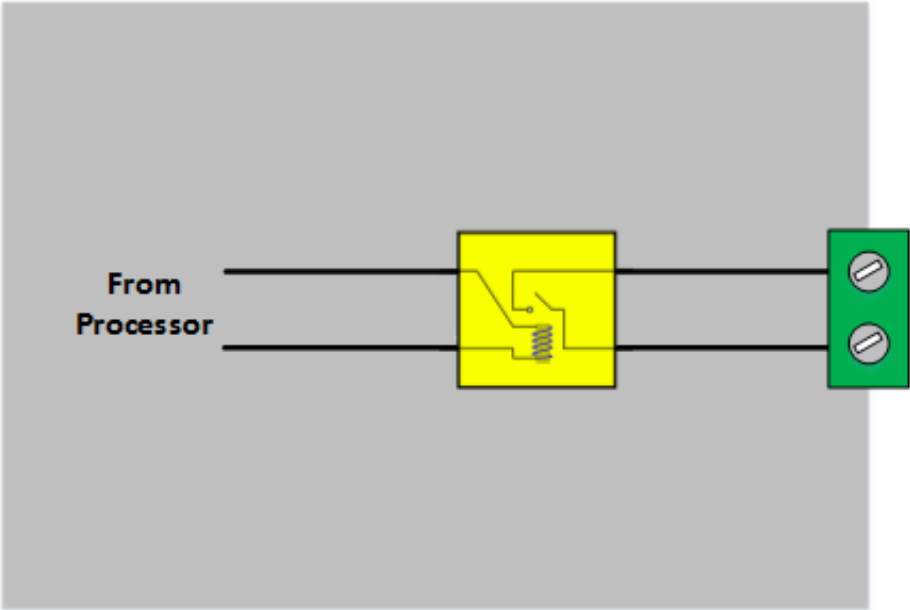

Figure 1-8 a circuit of the output port

The output port operates are as in the following

value	relay contact
0	OFF (open)
1	ON (short)

Table 1-4 values of the output port

The allowed output ports' electrical current of voltage conditions are as in the following:

Voltage Condition	Allowed current
DC28V	5A

Table 1-5 voltage conditions of the output port

*Use a (-) shaped screwdriver to connect it with users' devices since the output ports are interfaced with a 5mm terminal block,*

### 1.6.3 RS232 Port (DB9M)

CIE-H10 has an RS232 port supporting from 300 bps to 230,400 bps. This port is for connecting users' serial devices to Ethernet (TCP/IP) including the "Serialized Modbus/TCP".

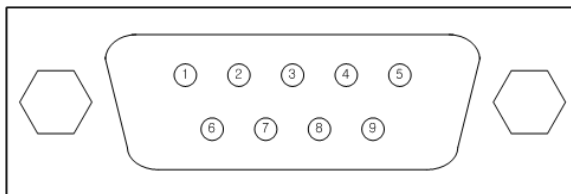

Figure 1-9 D-sub Male Connector

- Pin Assignment

No.	name	description	level	Dir.	Etc.
1	DCD	Data Carrier Detect	RS232	Input	NC
2	RXD	Receive Data	RS232	Input	required
3	TXD	Transmit Data	RS232	Output	required
4	DTR	Data Terminal Ready	RS232	Output	option
5	GND	Ground	Ground	-	required
6	DSR	Data Set Ready	RS232	Input	option
7	RTS	Request To Send	RS232	Output	option
8	CTS	Clear To Send	RS232	Input	option
9	RI	Ring Indicator	RS232	Input	NC

Table 1-6 pin assignment of the RS232 port

☞ **NC: Not Connected**

- Serial Port Parameters

Parameter	Value
Number	1
Type	RS232
Baud rate	300 ~ 230,400 [bps]
Parity	NONE / EVEN / ODD / MARK / SPACE
Data bit	8 / 7 / 6 5
Stop bit	1 / 1.5 / 2
Flow control	NONE, RTS/CTS, DTR/DSR

Table 1-4 serial port parameters

### 1.6.4 Ethernet Interface

An RJ45 connector is for the network interface of CIE-H10. You can use a UTP cable. It automatically senses 10Mbps or 100Mbps Ethernet. It also provides auto MDI/MDIX function that can automatically sense a 1:1 cable or cross over cable.

Each Ethernet device has its own hardware address (MAC address). CIE-H10 is shipped to the market with the hardware address set in the factory.

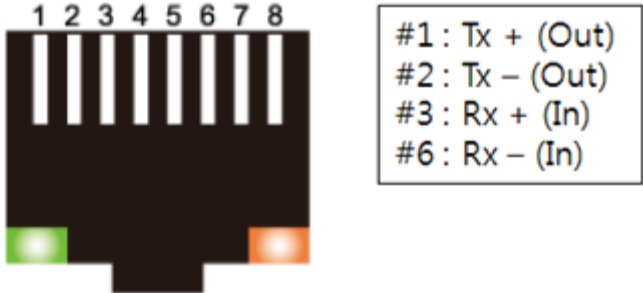

Figure 1-10 the RJ45 connector

### 1.6.5 Power

DC 5V is used for the power. The specification of the power jack is as following:

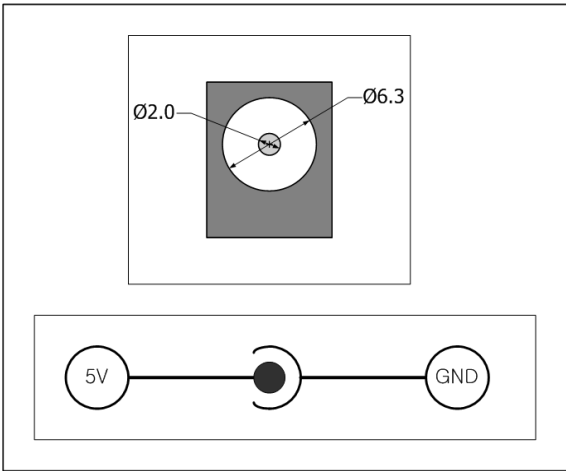

Figure 1-11 the power specification

### 1.6.6 System LED

CIE-H10 has 21 LEDs to indicate the current system status.

Each LED represents the following status:

mode	name	color	LED status	description
Common	PWR	Red	On	supplying the power
	LINK	Green	On	connected with 100M bit network
		Red	On	connected with 10M bit network
	RXD	Yellow	blinks	receiving data from the Ethernet
	TXD	Green	blinks	transferring data to the Ethernet
Normal mode	STS	Yellow	blinks every second	assigned an IP address
			blinks 4 times at once	without being assigned an IP address by DHCP or PPPoE
			On	establishing a Modbus/TCP connection
	DI	Yellow	On	when input ports' signal is ON
	DO	Green	On	when output ports' signal is ON
Serial Configuration mode	LINK, STS, RXD, TXD	-	blinks simultaneously	operating for the serial configuration mode
ISP mode	STS	Yellow	Off	operating for the ISP mode

Table 1-7 status of the system LED



### 1.6.7 ISP Switch

There is an ISP switch located on the side of the product. It is a switch allowing CIE-H10 to operate in the serial configuration mode or ISP mode. If you press it between 20ms and 1s, CIE-H10 will go into the serial configuration mode that you can configure the environment parameters through the RS232 port. If you press it over a second or supply power while pressing it, CIE-H10 will be operated as the ISP mode. In this mode, you can download the firmware file or HTML files.



Figure 1-12 ISP switch

☞ ***In the ISP and serial configuration mode, you are allowed to reset a password or cancel access restriction. Use these modes when you are faced with the problems.***

## 2 Installation and Test

### 2.1 Installation

In this section, we explain the way of CIE-H10 operation through a test. Basically, its input and output ports are independently used. Thus, you can use either the input ports only for monitoring or the output ports only for control. However, you can also correlatively use those ports by using the MACRO mode on the output ports.

Before testing CIE-H10, you should connect the Ethernet port to a PC. It will be no problem if the Ethernet connection is established through network hubs.



Figure 2-1 the connection between CIE-H10 and a PC

#### 2.1.1 Setting Network Area

This step is for setting both CIE-H10 and your PC to be located on the same network to establish a TCP connection.

- Setting of the PC

Add or change the IP address of the network adapter on your PC.

Click [Windows Control Panel] >> [Network Connections] and right click of your mouse to get into [Properties of the Network Adapter], then you will see the properties of [Internet Protocol (TCP/IP)]. Press the [Advanced Menu] button and add an IP Address as shown below.

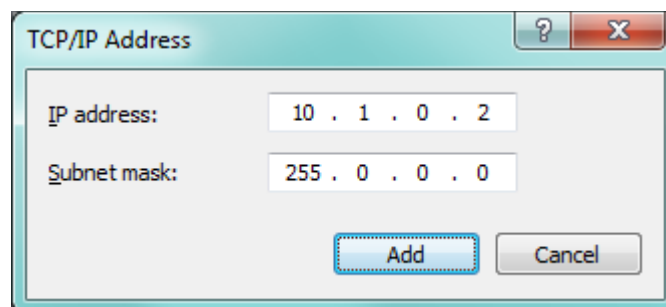

Figure 2-2 adding / changing an IP address

- Setting of CIE-H10

ezManager is the management tool for parameters of CIE-H10. This application is only for MS Windows and this is comfortable to use because it does not need installation process.

First, search your CIE-H10 via network. All the values of parameters are set to the default values in the factory. To apply it to your system, proper values should be set via ezManager.

Default values of some major parameters are listed on the table below. To do the following simple test, keep these values during the test.

Parameter		value
Network	Local IP Address	10.1.0.1
	Subnet Mask	255.0.0.0
Option	Telnet	Checked
	IP Address Search	Checked
Serial Port	Serial Type	RS232
	Baud Rate	19,200bps
	Parity	NONE
	Data Bits	8
	Stop Bit	1
	Flow	NONE
	Communication Mode	T2S – TCP Server
I/O Port	Local Port	1470
	Web (HTTP)	Checked
	Web (HTTP) Port	80
	Modbus/TCP	Checked
	Master/Slave	Slave
	Connection Mode	Passive Connection
	Multiple Connection	1
Local Port	502	

Table 2-1 default values of some major parameters

☞ ***You can download the latest version of ezManager on the [Download] >> [Utility] page on our website.***

## 2.2 Test operation

### 2.2.1 Modbus/TCP Test

This is for checking the operation of Input and output ports of CIE-H10 via Modbus/TCP. In this instruction, offered Modbus/TCP test program was used.

Run ezManager. Then, you can see the window as shown below.

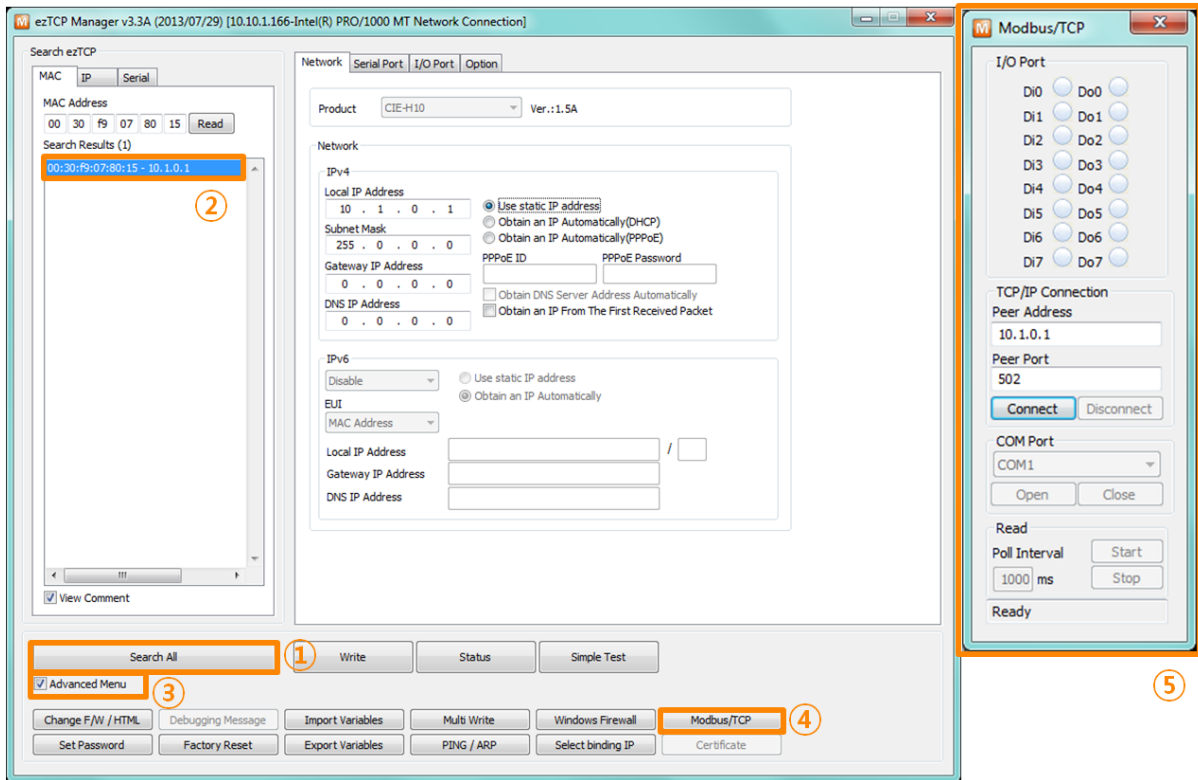

Figure 2-3 Modbus/TCP test program of the ezManager

- ① Search connected CIE-H10 with [Search All] button.
- ② Select a MAC address of searched product on the [search result].
- ③ Check the [Advanced Menu] option.
- ④ Press the [Modbus/TCP] button.
- ⑤ The test program will appear on the right side of the ezManager

*In the case of using previous versions of firmware than 3.1F the test program is shown automatically when you success in searching the product.*

● Modbus/TCP test

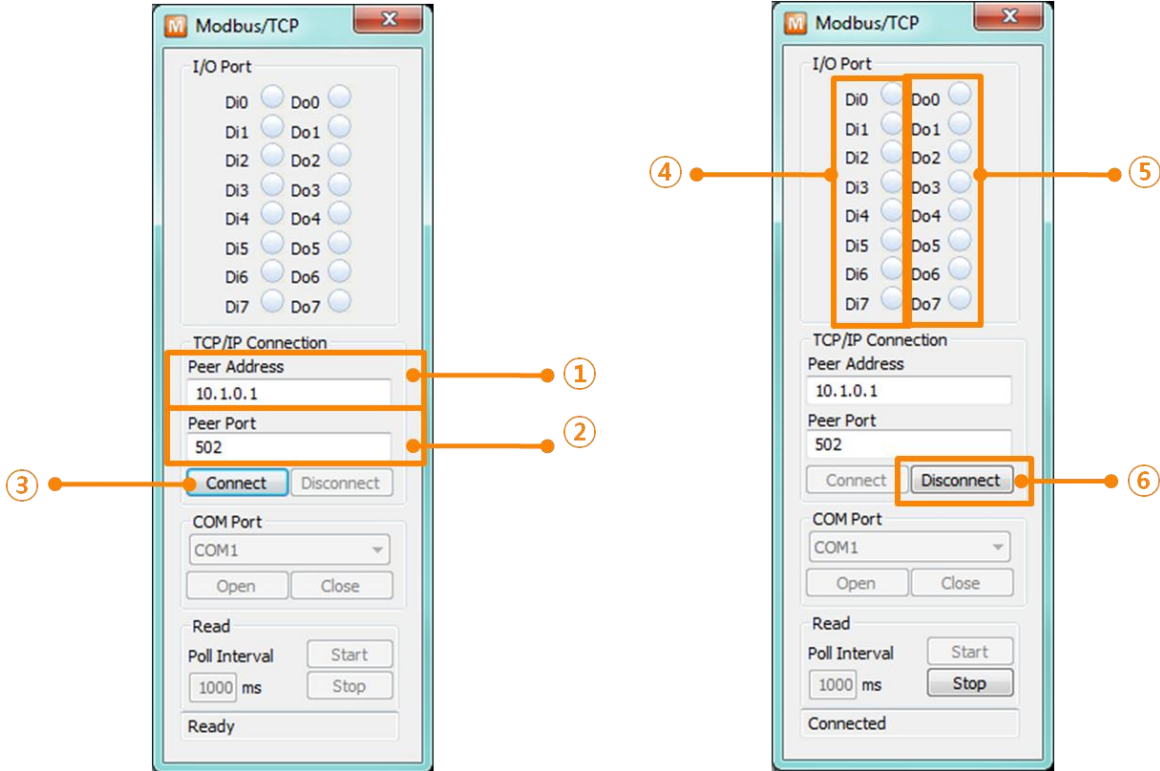

Figure 2-4 Modbus/TCP test

- ① Input the IP address of CIE-H10
- ② Input the local port for Modbus/TCP of CIE-H10

☞ ***In a local area network, ① and ② steps can be omitted.***

- ③ Try to connect by pressing [Connect] button
- ④ Under the connection, check if the Di LEDs are turned on or off with signal input
- ⑤ Check if Do LEDs are turned on or off with clicking the LEDs
- ⑥ Click the [Disconnect] button after the test is completed

### 2.2.2 HTTP Test with a WEB browser

This is for testing the operation of Input and output ports of CIE-H10 via HTTP. The test was implemented on a WEB browser. You can use WEB browsers such as MS Internet Explorer, Google Chrome and Mozilla Firefox.

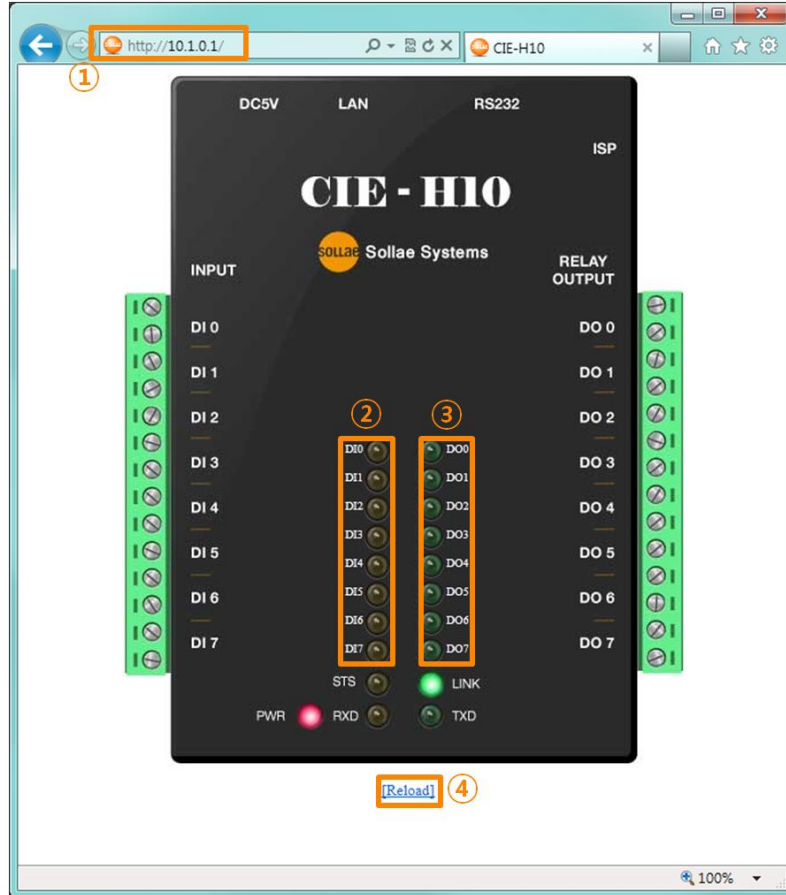

Figure 2-5 HTTP test

- ① Input the IP address of your CIE-H10 on the address field (Ex: 10.1.0.1).
- ② Check if the DI LEDs are turned on or off with HIGH signal.
- ③ Check if DO LEDs are turned on or off with clicking the each of LEDs.
- ④ Press the [Reload] button to update the status.

- The way to control output ports manually

	On/Off		Pulse
Parameter	oi (Lower case, i is port number)		pi (Lower case, i is port number)
Value	ON	OFF	Time (ms)
	1	0	1~10000
Example	<a href="http://10.1.0.1/index.html?o3=1">http://10.1.0.1/index.html?o3=1</a>		<a href="http://10.1.0.1/index.html?p3=1000">http://10.1.0.1/index.html?p3=1000</a>

Table 2-2 The way to control output ports manually

# 3 Configuration

## 3.1 Configuration with ezManager

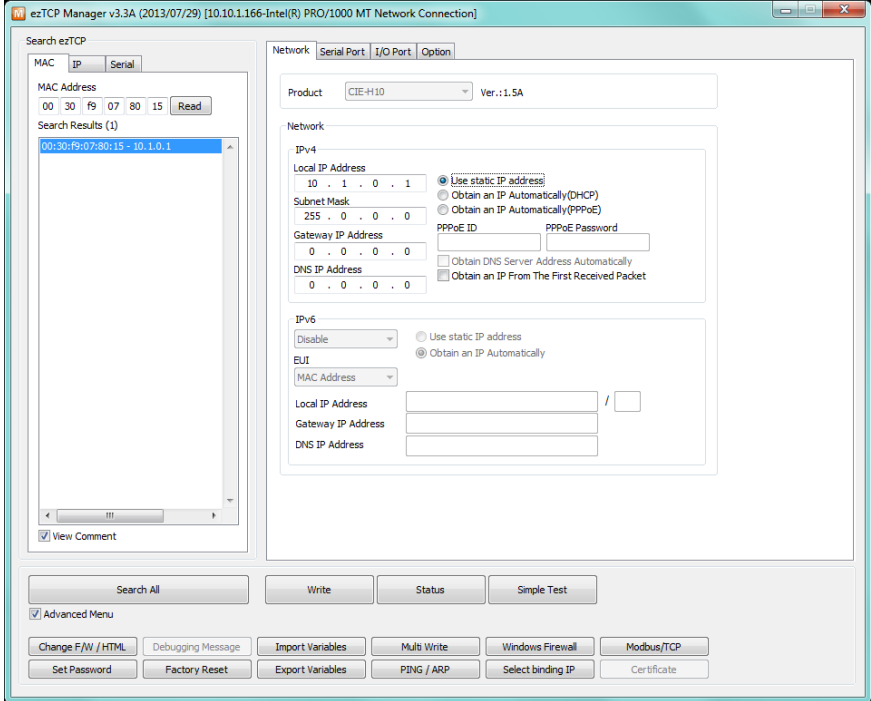

Figure 3-1 initial appearance of ezManager

### 3.1.1 Configuration via LAN

- Checklists
  - Make sure of the connection between your PC and CIE-H10 via Ethernet. If they are in the same network, [MAC Address search] button can be used. Otherwise, only [IP Address search] is allowed to use.

- Procedures

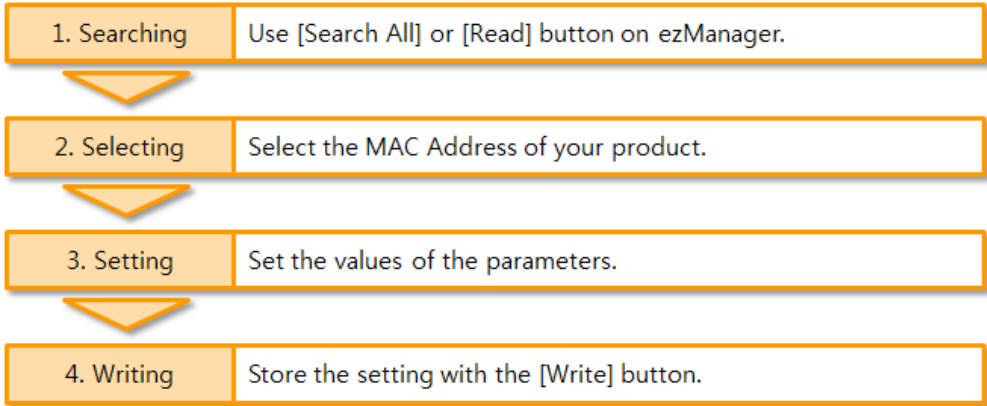

Figure 3-2 procedures for configuration via LAN

### 3.1.2 Configuration via Serial

- Checklists  
Make sure of the connection between your PC and CIE-H10 using a RS232 cross cable. CIE-H10 has to be operating in the [Serial Configuration] mode. You make CIE-H10 operate in the serial configuration mode by pressing the ISP- button less than 1 second. After then, read the setting on the [Serial] tab.

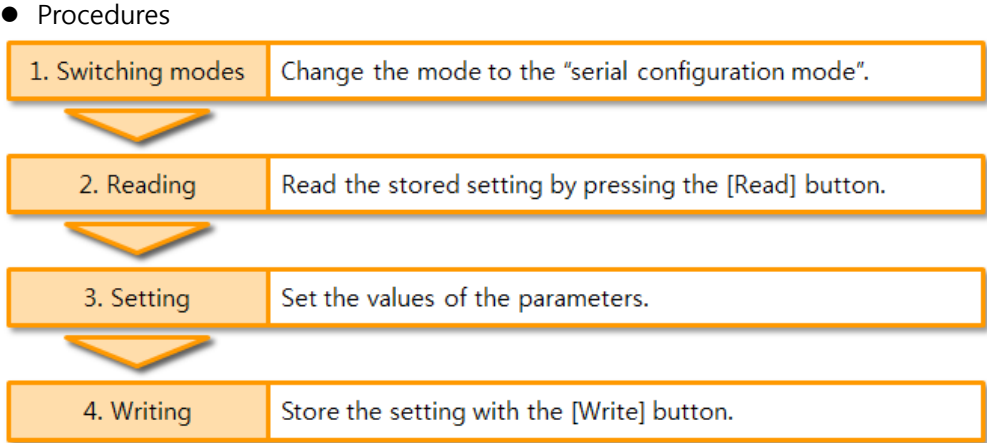

Figure 3-3 procedures for configuration via serial port

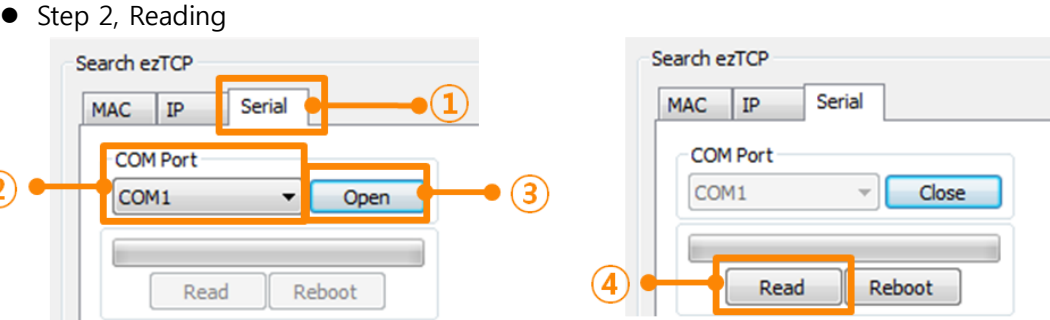

Figure 3-4 reading procedure via serial

- ① Choose the [Serial] tab.
- ② Select the COM port which is the device is connected.
- ③ Open the COM port pressing the [Open] button.
- ④ Load the setting with the [Read] button.

☞ Refer to the document [ezManager Manual] on our website for details.



### 3.2 AT command

In the AT command mode, you can change some parameters through the serial port.

- Checklists

Make sure of the connection between your PC and CIE-H10 using a RS232 cross cable. All the parameters of the serial port between CIE-H10 and the Terminal of your PC should be the same. In the AT command mode, you can change some parameters through the serial port.

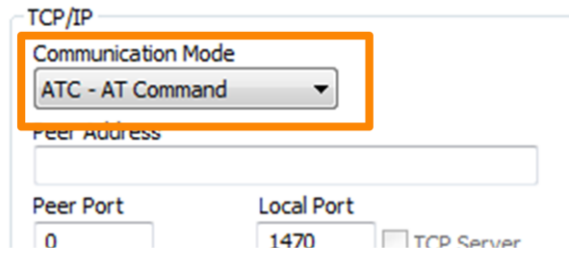

Figure 3-5 setting the communication mode to the AT command

- Procedures

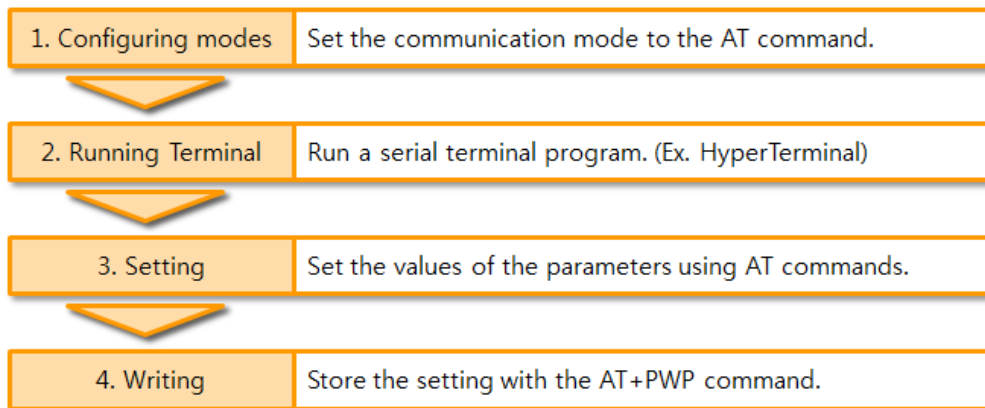

Figure 3-6 procedures for configuration with AT command

Division	Available parameters
IP Address related items	Local IP Address, DHCP, PPPoE, Subnet Mask, Gateway IP Address, DNS IP Address, ...
A TCP connection related items	Local Port, Peer Address (IP Address or Host name), Peer Port, ...
Option	ESC code sending option, timeout, ...

Table 3-1 parameters which are available to change with AT command

☞ ***Including above items, rest of parameters can be set by ezManager***

## 4 Operation Modes

### 4.1 What is the Operation Mode?

Each of three operation modes are designed for specific purposes, and those are as follows:

- Normal mode  
This mode is for normal data communication and has 5 different communication modes. Configuring parameters is also available in this mode.
- Serial configuration mode  
This mode is for configuring environmental parameters through the RS-232 port.
- ISP mode  
This mode is for upgrading firmware and HTML files. In addition, you can set environmental parameters even though the security options are activated. You can also reset the security options.

### 4.2 How to change the mode to another

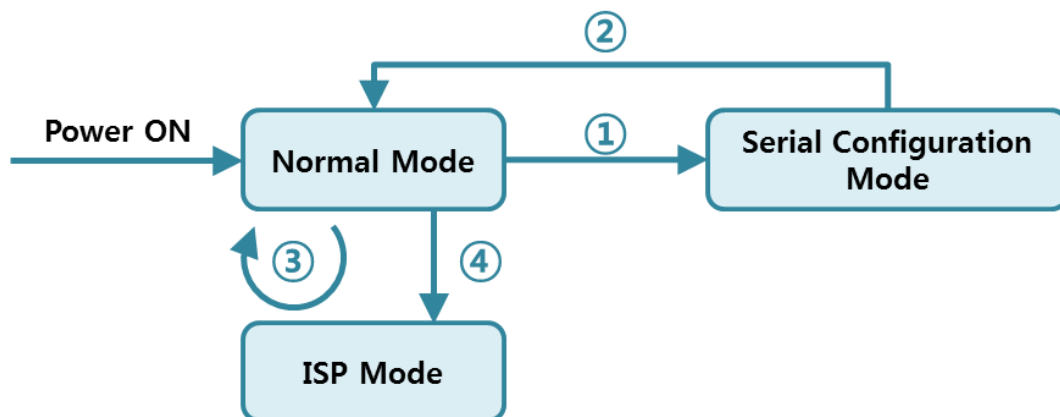

Figure 4-1 How to entering each mode

- ① Push the function button less than 1 second.
- ② Reset
- ③ Transfer a firmware by ezManager
- ④ Push the function button over than 1 second.

### 4.3 Comparison of the each mode

The following table shows summaries of each mode.

Name	Entering	Serial port
Normal	Supply the power.	Configured value
Serial Configuration	Press the ISP button shortly between 20ms and 1s.	115200/N/8/1
ISP	Supply the power with pressing the ISP button or press the ISP button over 1 sec in other modes.	115200/N/8/1

Table 4-1 comparison of the each mode

### 4.4 Normal Mode

In normal mode, there are four types of ways to monitor and control I/O and of additional operations as a Serial to Ethernet converter.

- I/O controller

type	description
Modbus/TCP	Control and monitor the I/O of CIE-H10 via Modbus/TCP. It supports both master and slave mode.
Serialized Modbus/TCP	CIE-H10 communicates through the RS232 port using the data format of Modbus/TCP.
Macro	Users can automatically control the output ports by setting MACRO using some basic formula of Boolean Algebra. Users can not control the output ports through HTTP or Modbus/TCP.
WEB(HTTP)	Users can monitor and control CIE-H10 via HTTP

Table 4-2 digital I/O control types

- Serial to Ethernet converter

CIE-H10 can be used as a Serial to Ethernet converter. There are four communication modes in this operation.

Name	Protocol	Connection	Modifying software of serial devices	Serial configuration	Topology
TCP Server	TCP	Passive	-	Not available	1:1
TCP Client		Active	-	Not available	1:1
AT Command		Either	Required	Available	1:1
UDP	UDP	-	-	Not available	N:M

Table 4-3 comparison of four communication modes

## 4.5 Serial Configuration mode

### 4.5.1 Configuring Parameters

This is a mode for setting environmental parameters through the serial port. If you cannot use the Network, this mode is only way to configure the parameters. Click the [Read] button on the [Serial] tab on ezManager after entering this mode.

☞ ***Refer to the [Serial Management Protocol] document on our website for details.***

### 4.5.2 Revoking Security Options

CIE-H10 offers strong functions for security like filtering with password or MAC and IP addresses. In the Serial Configuration mode, you can revoke all of these options. When you forget the password, enter this mode to change or delete it.

## 4.6 ISP mode

### 4.6.1 Upgrading Firmware

ISP mode is for upgrading firmware. Upgrading Firmware is implemented by ezManager. For more details about this, please refer to the clause 7.1.

### 4.6.2 Upgrading HTML

ISP mode can also upgrade HTML files. For more details about this, please refer to the clause 7.2.

### 4.6.3 Revoking Security Options

In the ISP mode, you can revoke all of these options like the serial configuration mode. When you forget the password, enter this mode to change or delete it.

## 5 Methods for I/O control

### 5.1 MODBUS/TCP

CIE-H10 supports Modbus/TCP. By using this protocol, it remotely monitors and controls I/O devices. To use this method, users' application should support this protocol.

#### 5.1.1 Related Parameters

parameter	description
Modbus/TCP	Using Modbus/TCP for controlling I/O ports of CIE-H10.
Slave	The slave responses by queries from the Master
Master	The Master sends queries to the slaves
Poll Interval	the period for sending queries (Unit: ms, Minimum value: 10)
Unit ID	ID for identifying the device or the pair of devices.
Input Port Base Address	Initial address of the input ports
Output Port Base Address	Initial address of the output ports
Passive Connection	waiting for accepting a Modbus/TCP connection
Active Connection	requesting a Modbus/TCP connection
Multiple Connection	The numbers for multiple Modbus/TCP connections.
Control Method of (FC XX)	Control method for the output ports of the slave (Single / Multiple)
Control Method of (AND/OR)	Control method for the output ports of the master (AND / OR)
Peer Address	Peer's IP address when CIE-H10 performs active mode.
Peer Port	Peer's local port when CIE-H10 performs active mode.
Local port	CIE-H10's local port when CIE-H10 performs passive mode.
Input Change Notification	A function for immediate notification with changing the IP address.
Initialize the output port state	The Output port will be changed to the [Initial State] when Modbus/TCP is disconnected. (Upper version 1.5A)
Macro	Applying macro function on the output port
Initial State	Output port value when CIE-H10 boots up.

Table 5-1 Modbus/TCP related parameters

☞ ***We do not recommend changing the [Input Port Base Address] and [Output Port Base Address] unless you need to.***

### 5.1.2 Modbus/TCP Slave Mode

According to the standard Modbus/TCP, users can use a Modbus/TCP manager to control and monitor their I/O devices. You can set CIE-H10 to the [Slave] item to [Slave] mode. The [Passive] connection is recommended in this mode and the [Peer Port] should be 502.

Modbus/TCP Mode	Slave
TCP Connection	Passive
TCP Port	502

Table 5-2 values for standard Modbus/TCP

Configure the proper values of [Unit ID], [Input Port Base Address], and [Output Port Base Address].

### 5.1.3 Modbus/TCP Master Mode

In this mode, CIE-H10 operates as a Modbus/TCP master. As a master CIE-H10 transmits its input information to the slave and outputs the slave's input value to its output port after reading the value periodically. At this stage, CIE-H10 controls the output ports with not only bit unit (individually) but also word unit (at once)

- FC 16(Multiple ports)  
CIE-H10 controls the output ports and monitors the input ports of slaves with WORD unit by FC16 (write multiple register) and FC 03 (read multiple register)
- FC 05(Single port)  
CIE-H10 controls the output ports and monitors the input ports of slaves with BIT unit by FC05 (write coil) and FC02 (read input - 30 -sages- 30 -s).

### 5.1.4 TCP Connection Modes

In the standard of Modbus TCP, the master program makes a connection to the slave using port number 502. However, sometimes Modbus/TCP devices try connecting to the master actively. For this case, CIE-H10 supports the active connection mode.

The passive connection	<ul style="list-style-type: none"> <li>- Standard Modbus/TCP.</li> <li>- Remote host connects to CIE-H10.</li> <li>- Port number that is used for communication must be designated.</li> <li>- Depending on the setting of multiple connections, up to 8 hosts can be connected.</li> </ul>
The active connection	<ul style="list-style-type: none"> <li>- CIE-H10 tries to establish a connection to the remote host.</li> <li>- The IP address (or host name) and port number of the remote host is required.</li> </ul>

Table 5-3 the passive / active connection

### 5.1.5 Initial Output Value

The initial value of CIE-H10's output port can be configured. The output ports are set to ON or OFF according to the value of [Initial State] at the boot time.

### 5.1.6 Write Pulse

By using the function code 105, you can give the signal of pulse type to the output ports. This means the output signal is kept during the specific time configured by users.

☞ ***Refer to the document [Modbus/TCP protocol] on our website for details.***

## 5.2 Serialized Modbus/TCP

Since 1.3A firmware, serialized Modbus/TCP mode had been added on the firmware. In this mode, CIE-H10 sends and receives Modbus/TCP data via the serial port. By using this mode, you can monitor and control the I/O ports of CIE-H10 through the RS232 port.

Note that you can't control the output ports of CIE-H10 with HTTP or Modbus/TCP in this mode. Also, the TCP and UDP data communication for serial devices cannot be activated.



## 5.3 Macro Mode

This mode lets users set the values of the output ports with simple macros. Since CIE-H10 reflects the values according to the macro expressions which are configured by users in advance, it is useful to make a specific device operate automatically using signals from various sensors. Check [Macro] options on ezManager to activate this mode.

☞ ***While using the Macro mode, users can not control the output ports through HTTP or Modbus/TCP.***

### 5.3.1 Operator

The algorithm used in the Macro mode is Boolean algebra. In this case, the AND, OR, NOT are used as operators. Parenthesis may also be used.

The operators are executed in order of precedence: parenthesis > NOT > AND > OR. Each operator is represented by the following symbols.

Name	sign	description
Parenthesis	( )	Since calculations within the parenthesis have the highest priority, they will be calculated first. Nested parentheses are allowed.
NOT	/	An operand that follows a NOT operator is toggled. (If an operand is 0, it will be changed to 1. If it is 1, it will be changed to 0.)
AND	*	If both operand values surrounding an AND operator are 1, the result value will be 1. But if otherwise, the result will be 0.
OR	+	If both operand values surrounding an OR operator are 0, the result value will be 0. But if otherwise, the result will be 1.

Table 5-4 the operators

### 5.3.2 Operand

Operands used in macro mode are each input port. Each input port is designated with i0 ~ i7 symbol based on their sequence. Since capital letters are not recognized, they can also be written as I0 ~I7.

☞ ***The output ports could not be used as an operand.***

### 5.3.3 An Example of Equations

Here are some examples. In the expressions, spaces between the two operands will be ignored.

Input Port	Equations	Description
Do0	$i0 + i1$	Perform OR for i0 and i1.
Do2	$i0 * /(i1 + i7)$	The part of the expression within the parentheses, (i1 + i7) is evaluated first, and then the value is toggled due to a NOT operator. This result is used to perform an AND operator with i0.

Table 5-5 an example of equation

The following is the output values coming out as a result of expressions of input values.

Input port value			Output port value	
i0	i1	i7	Do0	Do2
0	0	0	0	0
0	0	1	0	0
0	1	0	1	0
0	1	1	1	0
1	0	0	1	1
1	0	1	1	0
1	1	0	1	0
1	1	1	1	0

Table 5-6 the logic table of the table 5-5

## 5.4 Web (HTTP)

After starting the web browser, type CIE-H10's IP address after typing http:// in the address bar to connect to CIE-H10

If a password for CIE-H10 is set, the following window will be popped up.

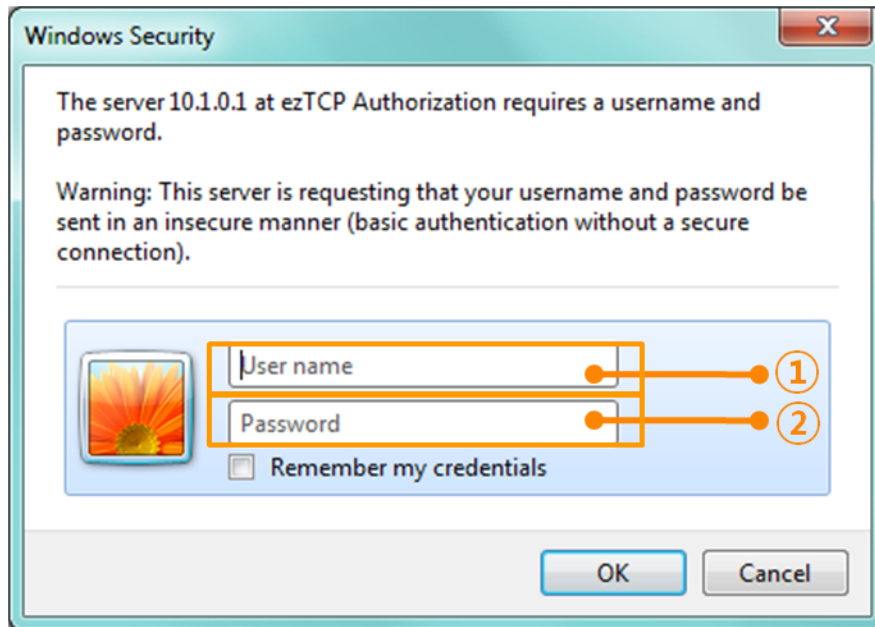

Figure 5-1 authentication with a password

- ① [User name] is not required. Leave blank or put a random name.
- ② [Password] should be the same with a password which is set through the ezManager.

### 5.4.1 Changing port number for HTTP

In case you cannot use the port number 80(default port number for HTTP) because the ISP (Internet Service Provider) blocks the port, you can change that port number.

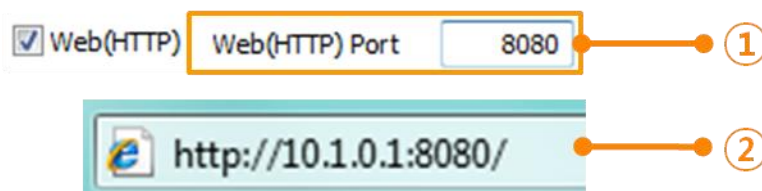

Figure 5-2 changing port number for HTTP

- ① Input a port number to the [Web(HTTP) Port] box.
- ② Input the IP address of CIE-H10 along with the changed port number and "http://"

### 5.4.2 Uploading Users' Web Page

1.3A or subsequent versions of firmware support uploading custom web page. This function is available to anyone who can make HTML files. If you get some simple syntax, it is possible to monitor and control the I/O ports with your homepage interface.

- Upgrading Boot and Firmware

To use this function, it is needed for users who have been using 1.5 version of boot and 1.2C version of firmware or lower versions. If you have already got the updated products, you don't need this process.

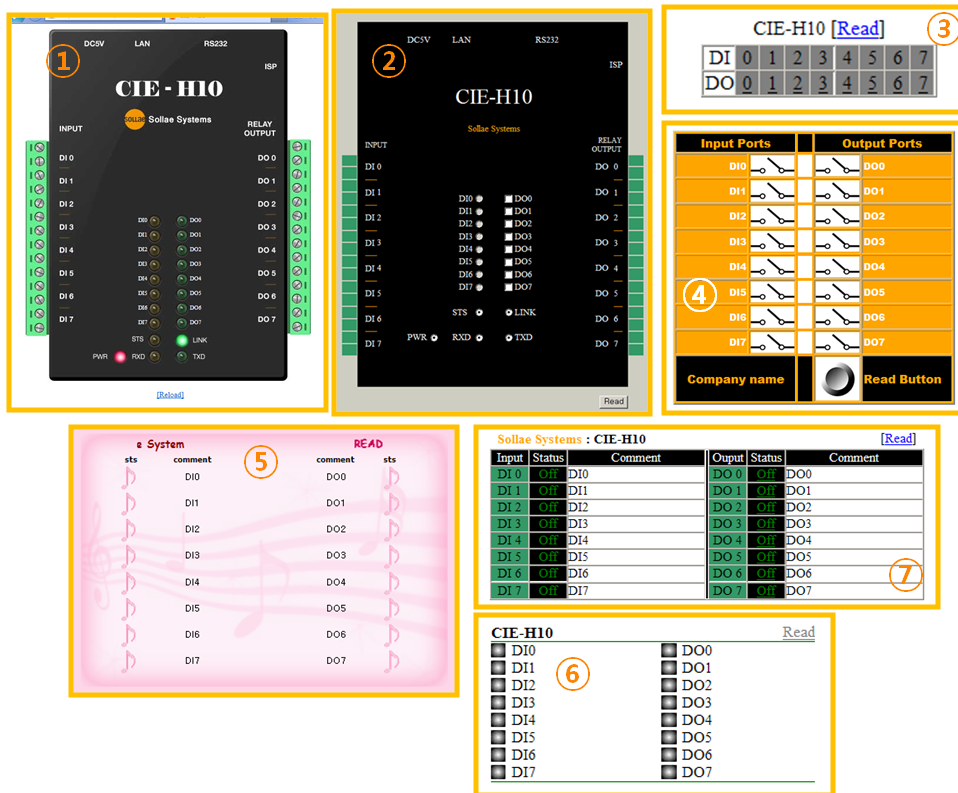

Figure 5-3 examples of web page

- ① Default image
- ② Default text
- ③ No comment
- ④ Sample01
- ⑤ Sample02
- ⑥ Simple image
- ⑦ Simple text

☞ ***If you cannot use this function, you should upgrade the version of boot even though your CIE-H10 has the latest version of F/W.***

☞ ***For more information about the upgrading boot, please refer to the [CIE-H10\_upgrading Boot and F/W] document on our website for details.***

## 6 Communication Modes

CIE-H10 provides RS232↔TCP/IP conversion function along with input/output port monitoring and controlling function.

### 6.1 TCP Server

In this mode, CIE-H10 acts as a TCP server. CIE-H10 waits for a TCP connection from remote hosts. Once one of hosts tries to connect to CIE-H10, it responds to that request. After the connection is established, CIE-H10 converts the raw data from the serial port to TCP/IP packets and sends the packets to the network and vice versa.

#### 6.1.1 Key parameters

- Local Port

This is a server's port number which is used in the TCP connection.

- Event Byte

With setting event bytes, users can handle the serial data before a TCP connection is established.

Value	Description
0	CIE-H10 does not send the data.
Otherwise (512 or under)	CIE-H10 sends the data right after a connection is established. 512 or under bytes are strongly recommended.

Table 6-1 Event Byte

- Timeout

If there is no data transmission for the specific time, CIE-H10 terminates the established TCP connection.

- Notify IP Change

This function is for notifying information about changed IP address to a server. Not only the TCP/UDP protocol but Dynamic Domain Name Service (DDNS) can be used.

- Restriction of Access(ezTCP Firewall)

Users can block TCP connections from unauthorized hosts by using this option. Both IP and MAC address are available.

### 6.1.2 An Example

- An example as a TCP server

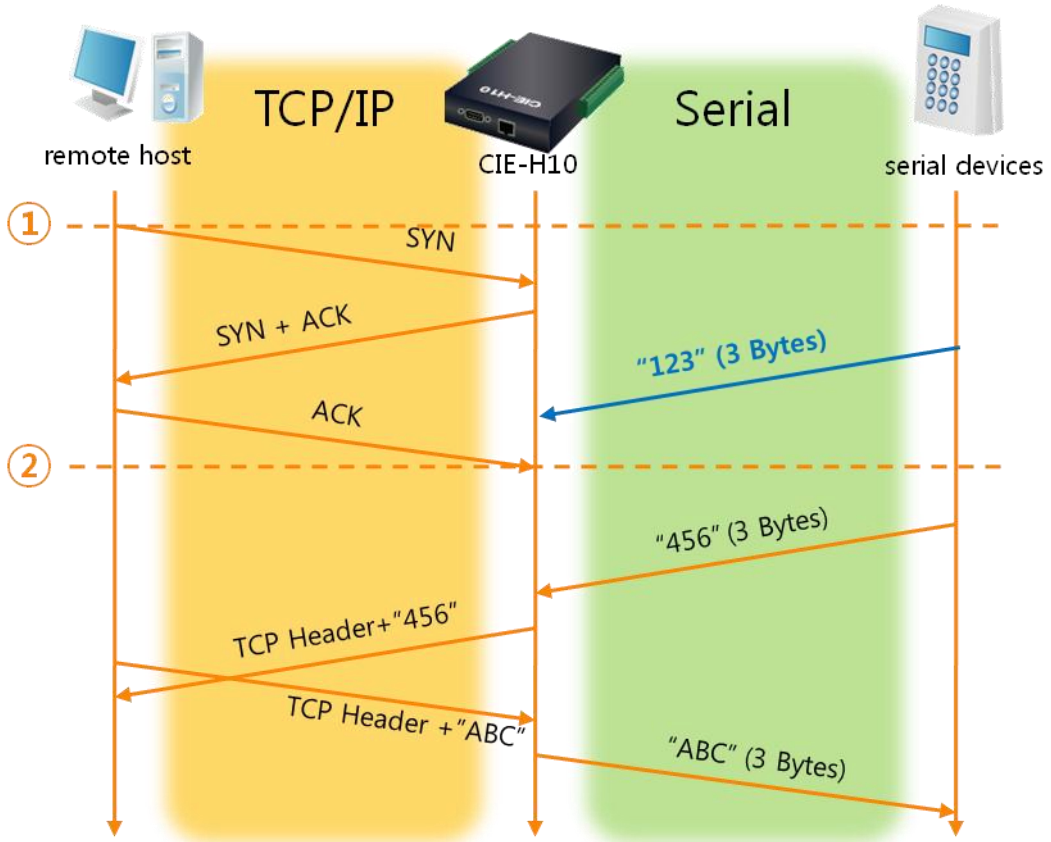

Figure 6-1 TCP server

Point	State
~	CIE-H10 is waiting for request segments of a TCP connection
①	Remote host has sent a request (SYN) segment
~	Processes of the connection
②	The connection has been established
~	Data communication on both sides

Table 6-2 descriptions of each state

## 6.2 TCP Client

In this mode, CIE-H10 acts as a TCP client. CIE-H10 sends request segments to a remote host with information of [Peer Address] and [Peer Port]. Under situation that the TCP server works fine with the specific port, the connection will be established. After then, CIE-H10 converts the raw data from the serial port to TCP/IP data and sends them to the network and vice versa.

### 6.2.1 Key parameters

- Peer Address

This item should be an address of a remote host who is waiting requests of a TCP connection.

- Peer Port

[Peer Port] should be the port number which is designated by the remote host.

- Event Byte

CIE-H10 decides the time to send request segments for the TCP connection with this parameter.

Value	Description
0	CIE-H10 sends a request segment of the TCP connection right after it boots up
Otherwise (512 or under)	CIE-H10 sends the segment right after it received amount of data which is set to the [Event Byte] from the serial port

Table 6-3 the operation of Event Byte 1

In addition, users can handle the serial data before a TCP connection is established with this parameter.

Value	Description
0	CIE-H10 doesn't send the data.
Otherwise (512 or under)	CIE-H10 sends the data right after a connection is established. 512 or under bytes are strongly recommended.

Table 6-4 the operation of Event Byte 2

- Timeout

If there is no data transmission for the specific time, CIE-H10 terminates the established TCP connection.

- TCP Server

This check option is enable the TCP server / client mode. In this mode, CIE-H10 can be operated as a TCP server or client without changing its setting.

- DNS IP Address  
[DNS IP Address] is required when users use a host name instead of the IP address on the [Peer Port] parameter.

### 6.2.2 An Example

- An example of TCP client

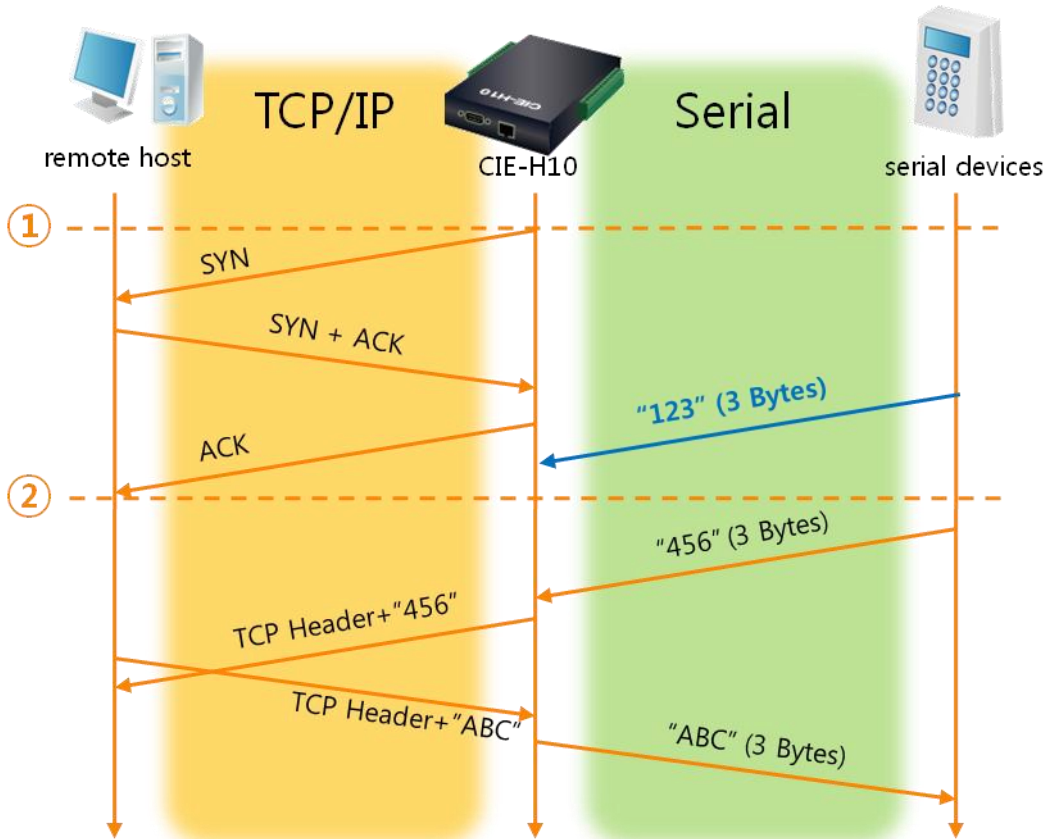

Figure 6-2 time chart for a situation that [Event Byte] is set to 0

Point	State
~	Before the power is supplied
①	Sends request segments of a TCP connection right after it boots up
~	Processes of the disconnection
②	The connection has been established
~	Data communication on both sides

Table 6-5 descriptions of each state



- Activation of [TCP Server] option

In the TCP client mode, the [TCP Server] check option is activated. If you check this option, CIE-H10 operates in the TCP server/client mode. In this mode, CIE-H10 can establish a TCP connection both actively and passively without changing any settings.

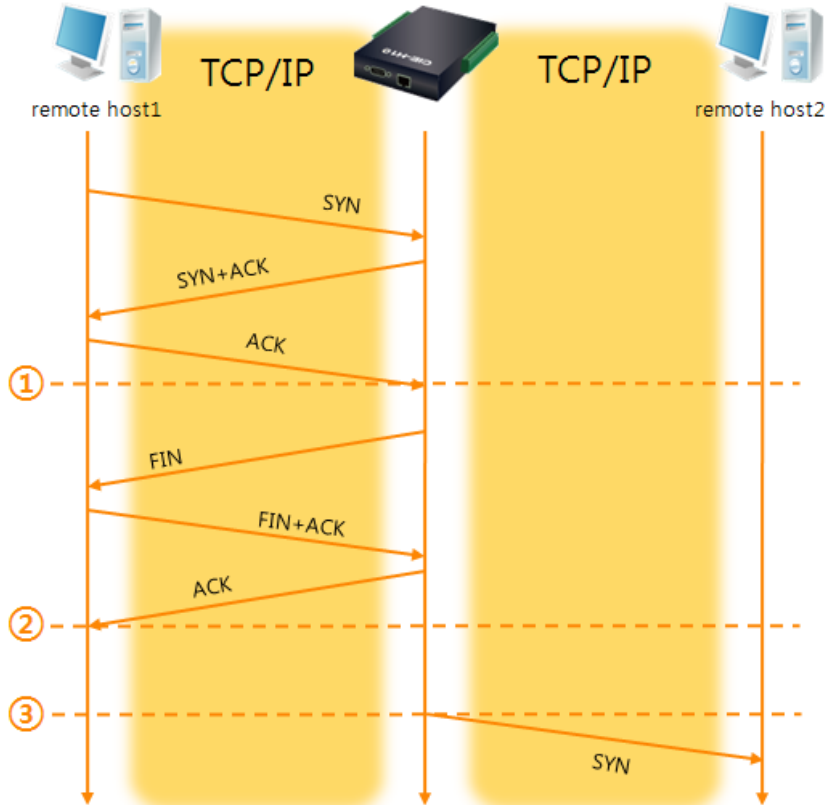

Fig 6-4 time chart for activating [TCP Server] option

Point	State
~	CIE-H10 is waiting for request segments of a TCP connection
①	The connection has been established
~	CIE-H10 is on line and processes of the disconnection
②	The connection has been terminated
~	Both sides are offline
③	Sends a request segment of a TCP connection

Table 6-6 descriptions of each state

The TCP Server/Client mode only can be a useful option under condition of using [Event Byte] and [Timeout]. Note that only one TCP connection can be established at the same time, so users should consider setting [Timeout] properly.

☞ **Refer to the [TCP Server/Client mode] document on our web site for details.**

## 6.3 AT Command

AT command is a mode which users control CIE-H10 with AT command like controlling modem. In this mode, active and passive TCP connections are available. And users are allowed to configure some environmental parameters with extended commands.

### 6.3.1 Key parameters

The configuration should be implemented via the serial port of CIE-H10

Commands	Description	Examples
+plip	Local IP Address	at+plip=10.1.0.1 <CR>
+plp	Local Port	at+plp=1470 <CR>
+prip	Peer IP Address	at+prip=10.1.0.2 <CR>
+prp	Peer Port	at+prp=1470 <CR>
+pdc	DHCP	at+pdc=1 <CR> (On)
+pto	Timeout	at+pto=10 <CR>
+pwp	Store setting	at+pwp <CR>

Table 6-7 some of extended commands for configuration

- Related items with the IP Address and Local Port  
As well as the local port, the IP address related parameters such as IP Address, Subnet Mask and Gateway IP Address can be set.
- Peer Address / Peer Port  
IP address and local port of a remote host are can be set.
- Type of assigning the IP address: Manual, DHCP, PPPoE  
Not only manual setting, also automatic assigning protocol (DHCP, PPPoE) is available.
- The others  
Some of options including [Timeout] can be configured in this mode.

### 6.3.2 Examples

- TCP Server – setting parameters and a passive connection

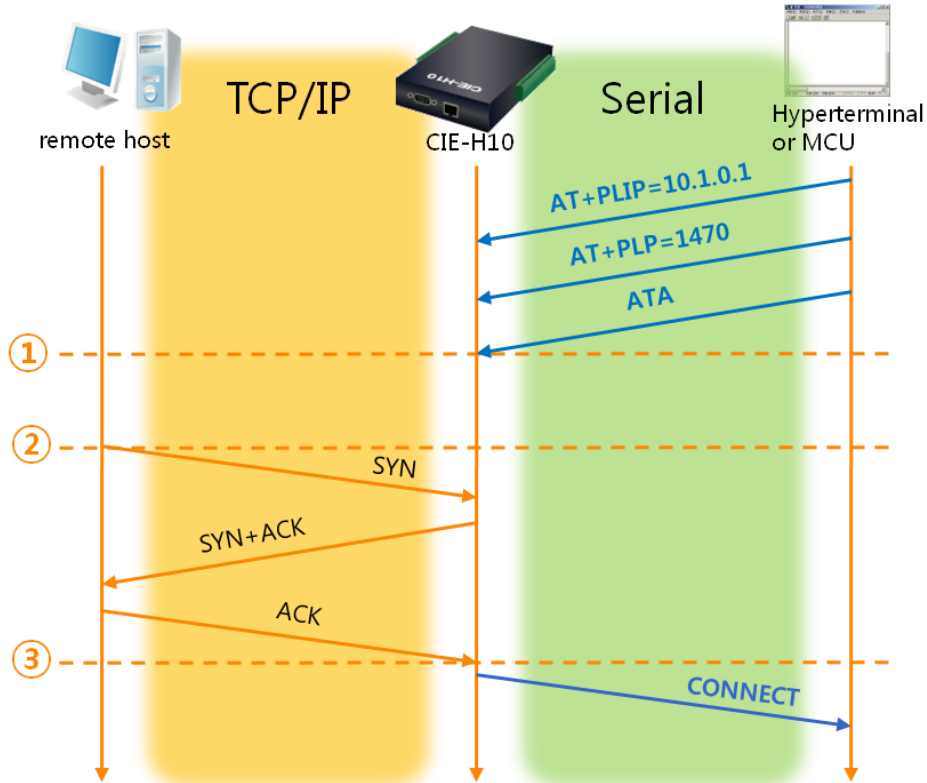

Figure 6-5 a passive TCP connection

Point	State
~	Set parameters in the AT command mode
①	CIE-H10 waits request segments of a TCP connection with the ATA command
~	CIE-H10 is waiting for requests of a TCP connection
②	A remote host has sent SYN segment to CIE-H10
~	Processes of the TCP connection
③	TCP connection has been established
~	CIE-H10 sends "CONNECT" message to the serial port

Table 6-8 descriptions of each state

☞ **Most of the response messages from the serial port of CIE-H10 are omitted on above figure.**

- TCP Client – setting parameters and an active connection

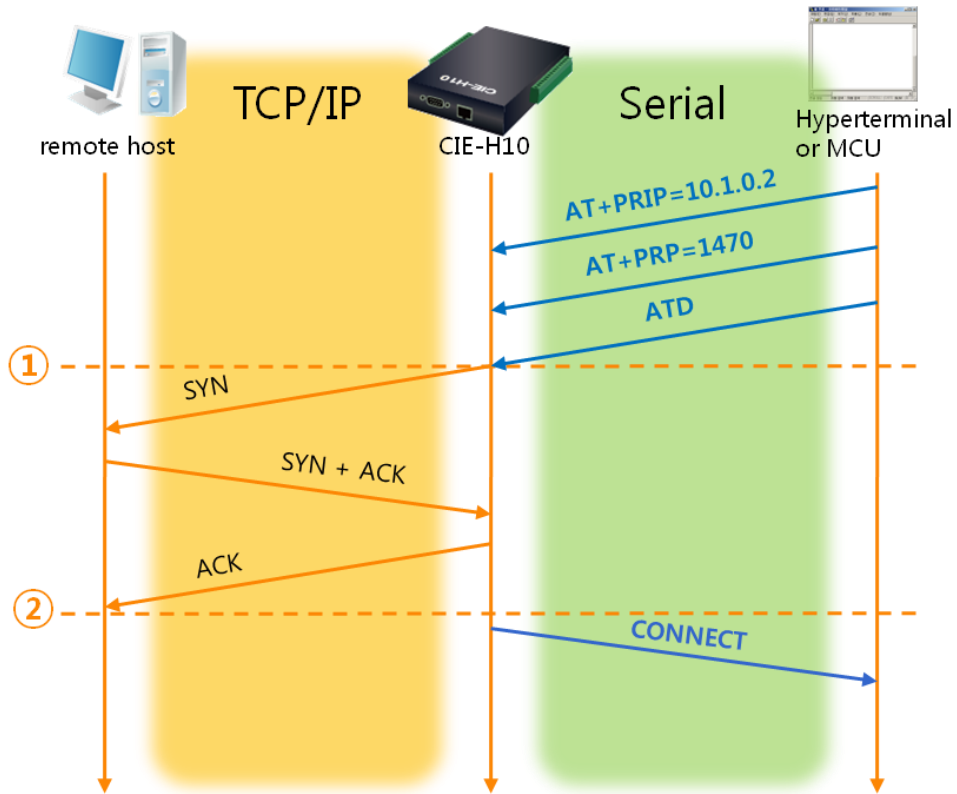

Figure 6-6 an active TCP connection

Point	State
~	Set parameters in the AT command mode
①	CIE-H10 sends a request segment of a TCP connection with the ATD command.
~	Processes of the TCP connection
②	The TCP connection has been established.
~	CIE-H10 sends "CONNECT" message to the serial port.

Table 6-9 descriptions of each state

☞ **Refer to the [ATC mode] document on our web site for details.**

## 6.4 UDP

UDP has no processes of a connection. In this mode, data is sent in block units. Therefore, data that comes through CIE-H10's serial port must be classified in block units to be sent elsewhere.

### 6.4.1 Key parameters

- Block Size(Byte)

[Block Size] means the size of a block in UDP mode. Its unit is byte. Recognizing specific sized data coming into the serial port, CIE-H10 sends them as one block to the network. The value is up to 1460 bytes.

- Data Frame Interval

[Data Frame Interval] means the time for gathering data to make them into a block. Its unit is 10ms. If there is no transmission for specific time which is set to this value, CIE-H10 sends gathered data in the buffer as one block to the network.

☞ ***A UDP packet block is sent if applicable to either of [Block Size] and [Data frame Interval].***

- Dynamic update of Peer host

If users set the value of [Peer Address] and [Peer Port] to 0, [dynamic update of peer host] function is activated. By using this function, CIE-H10 can communicate with multiple hosts without additional setting.

6.4.2 Examples

- Block Size: 5 bytes / Data Frame Interval: 1s (100 \* 10ms)

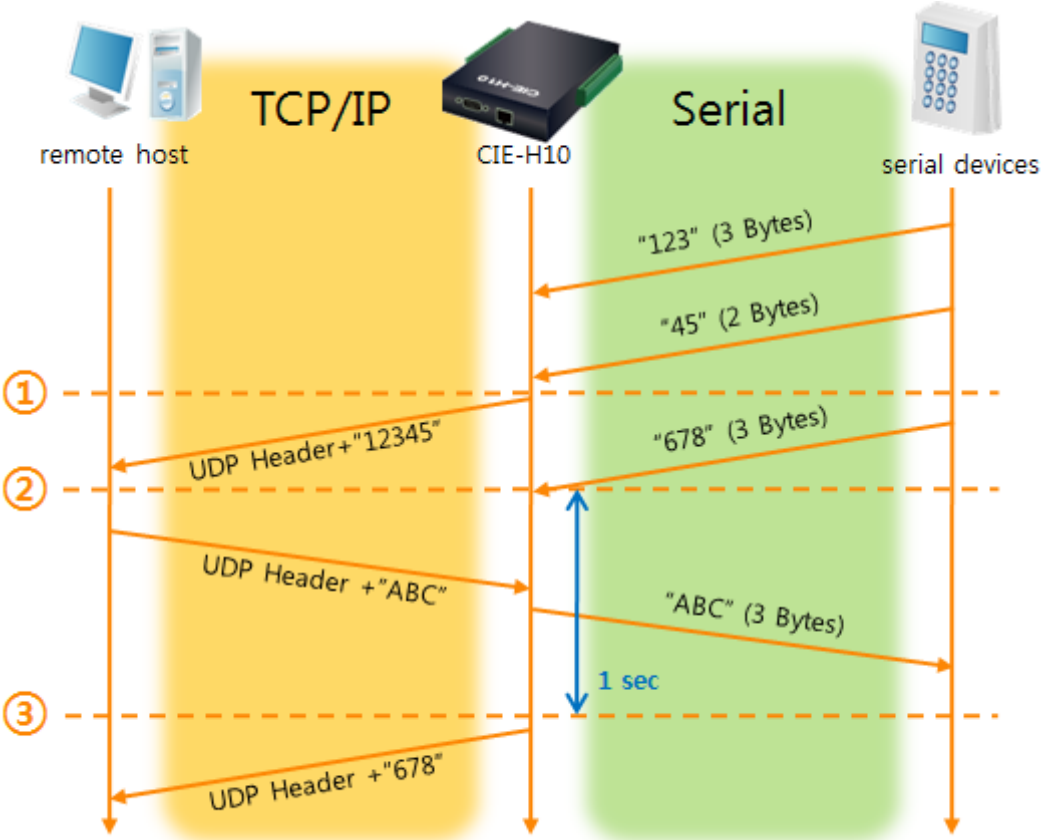

Figure 6-7 time chart for block size is 5 bytes and Data Frame Interval is 1s

Point	State
~	CIE-H10 is receiving data from the serial port
①	CIE-H10 Sends 5 bytes as one block based on the [Block Size]
~	Serial device sends data "678" to CIE-H10
②	Data "678" has arrived
~	CIE-H10 sends data from the remote host to the serial device
③	1 second has passed
~	CIE-H10 sends data "678" based on the [Data Frame Interval]

Table 6-10 descriptions of each state

- Dynamic Update of Peer host

This is a function that CIE-H10 automatically sets its peer host with information of the last packet which is received from network. In the packet, the source address and port number are used.

Parameter	Value
Peer Address	0 (None)
Peer Port	0

Table 6-11 setting for [dynamic update of peer host] function

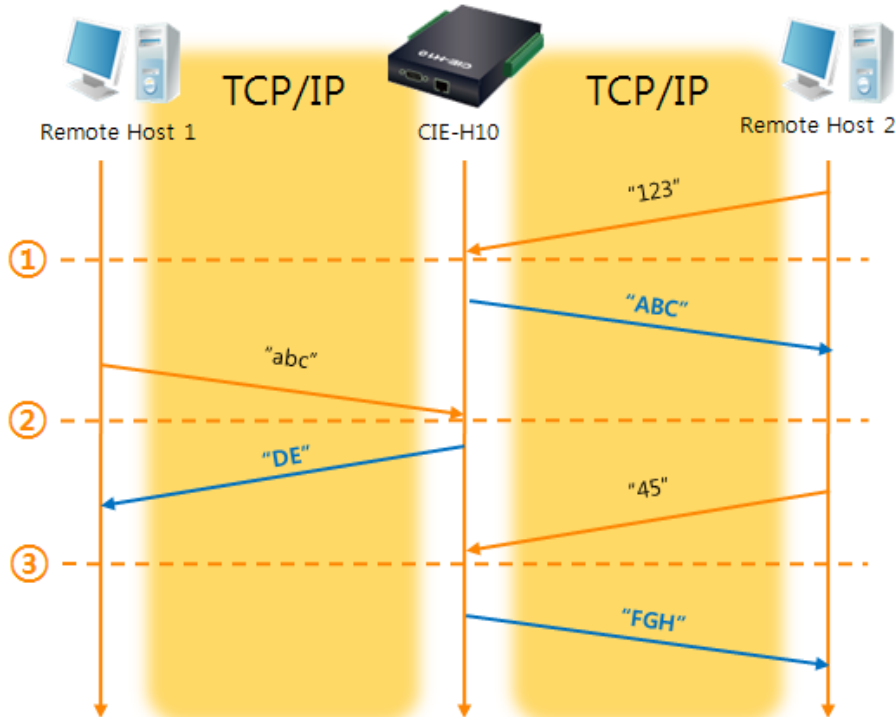

Figure 6-8 Time chart for [dynamic update of peer host]

Point	State
~	Sending any UDP data to the network is impossible.
①	UDP data arrives from Remote Host 2.
~	Send UDP data to Remote Host 2.
②	UDP data arrives from Remote Host 1.
~	Send UDP data to Remote Host 1.
③	UDP data arrives from Remote Host 2.
~	Send UDP data to Remote Host 2.

Table 6-12 descriptions of each state

☞ ***"ABC", "DE", and "FGH" in the above figure are the data that CIE-H10 receives from a serial port and send to the network.***

## 7 System Management

### 7.1 Upgrading Firmware

#### 7.1.1 Firmware

Firmware is a type of software for operation of CIE-H10. If it is needed to add function or fix bugs, the firmware will be modified and released. We recommend that users keep using the latest released firmware.

#### 7.1.2 Processes

- Downloading the latest released firmware  
Download the newest firmware file. We update our homepage when a new firmware is released. You can find it on our website.
- Entering ISP mode  
Enter ISP mode to download firmware file to CIE-H10.
- Run a TFTP client and ready to send the F/W file  
Run a TFTP client program. ezManager is equipped with the client program. Click the [Change F/W / HTML] button.

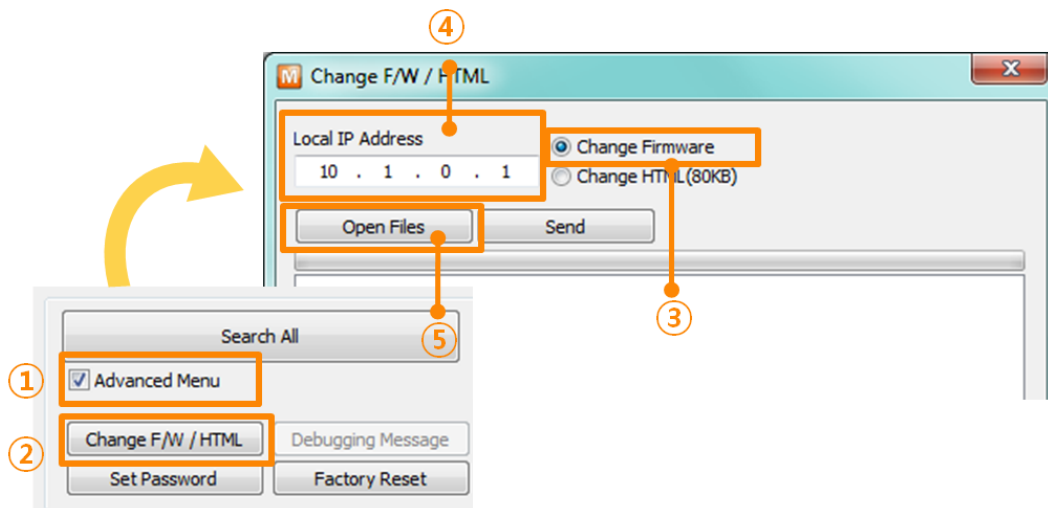

Figure 7-1 running TFTP client

- ① Check the [Advanced Menu] check box
- ② Click the [Change F/W / HTML] button to run TFTP client
- ③ Select the [Change Firmware] radio button
- ④ Input the IP address of CIE-H10 to the [Local IP Address] text box
- ⑤ Press the [Open Firmware / HTML] button and choose the firmware file



● Checking firmware file and Sending

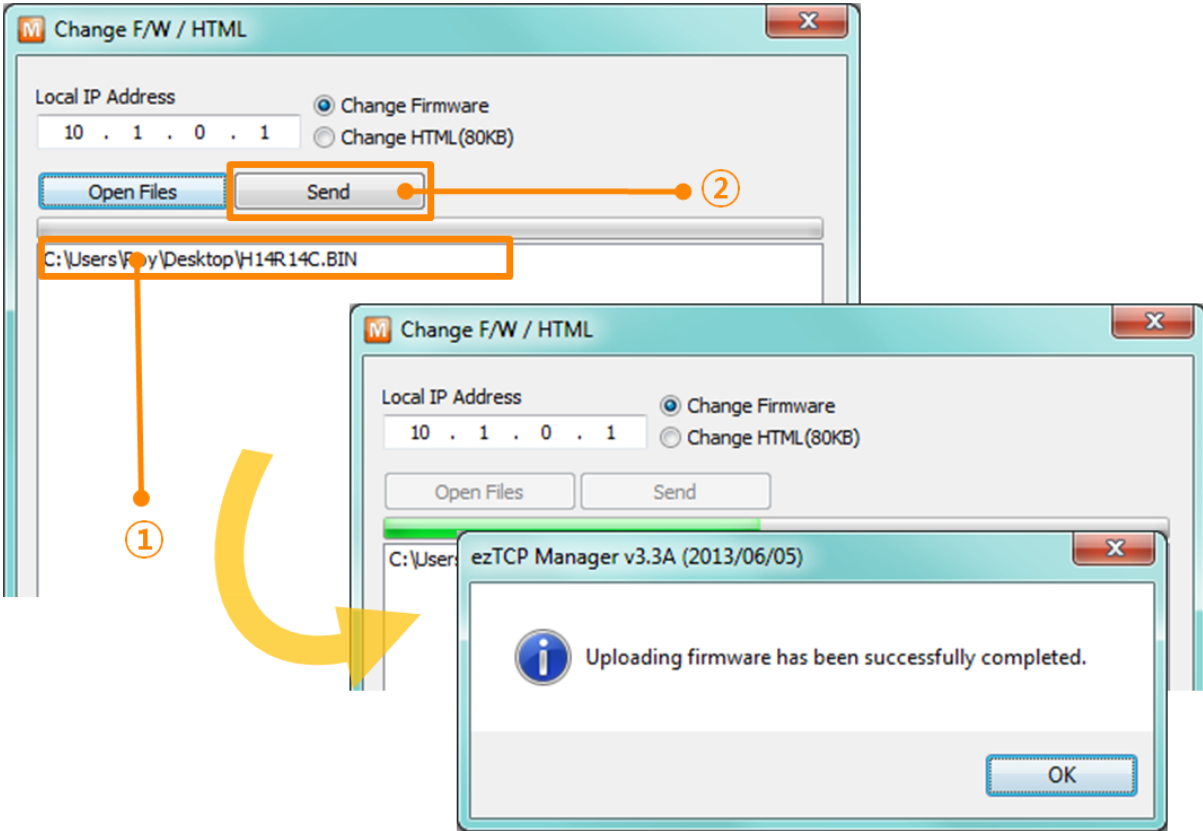

Figure 7-2 sending firmware file

- ① Check if the name and path of the firmware file are correct
- ② Click the [Send] button
- ③ Confirm the completed message

## 7.2 Changing Webpage

### 7.2.1 Webpage

CIE-H10 comes preloaded with a webpage to facilitate control and monitoring through HTTP.

### 7.2.2 Processes

- Making Users' webpage or Downloading sample files  
Make your own webpage file or use sample webpage files freely available to download at our web site.
- Entering ISP mode  
Enter ISP mode to send HTML files to CIE-H10.
- Writing Web(HTTP) port number and selecting size of Web(HTTP)

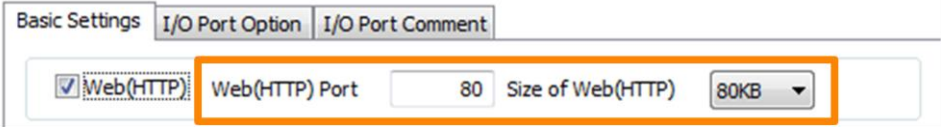

Figure 7-3 Web Basic Settings

☞ **80KB or 96KB for the Size of Web(HTTP) is allowed.**

- Running a TFTP client and ready to send the HTML files  
Run a TFTP client program. ezManager is equipped with the client program. Click the [Change F/W / HTML] button.

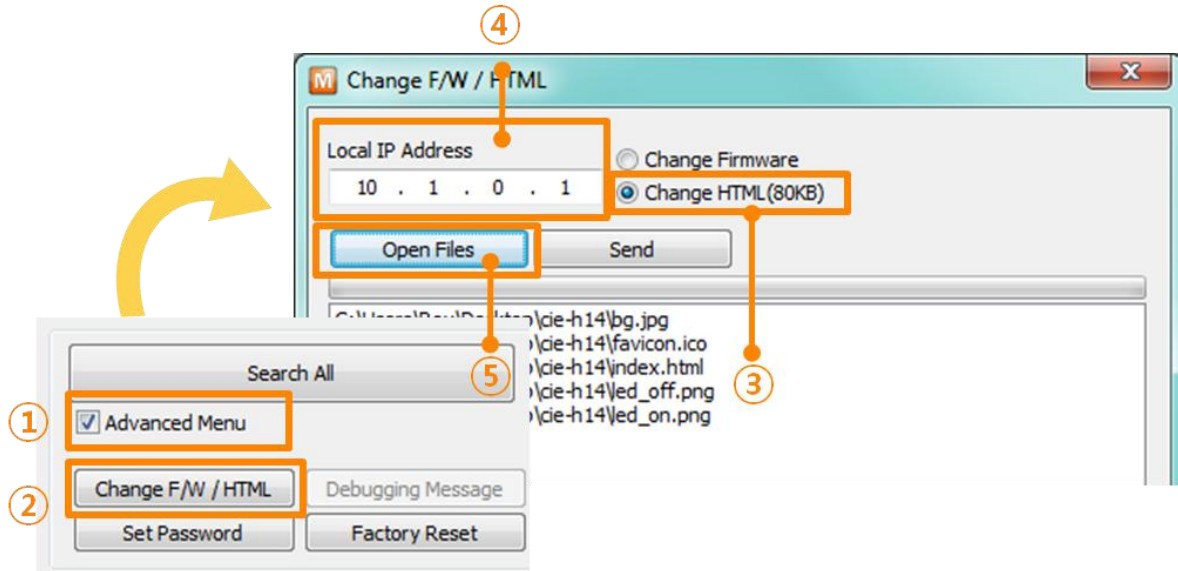

Figure 7-4 running TFTP client

- ① Check the [Advanced Menu] check box
- ② Click the [Change F/W / HTML] button to run TFTP client
- ③ Select the [Change HTML] radio button
- ④ Input the IP address of CIE-H10 to the [Local IP Address] text box
- ⑤ Press the [Open Files] button and choose the HTML file

● Checking files and Sending

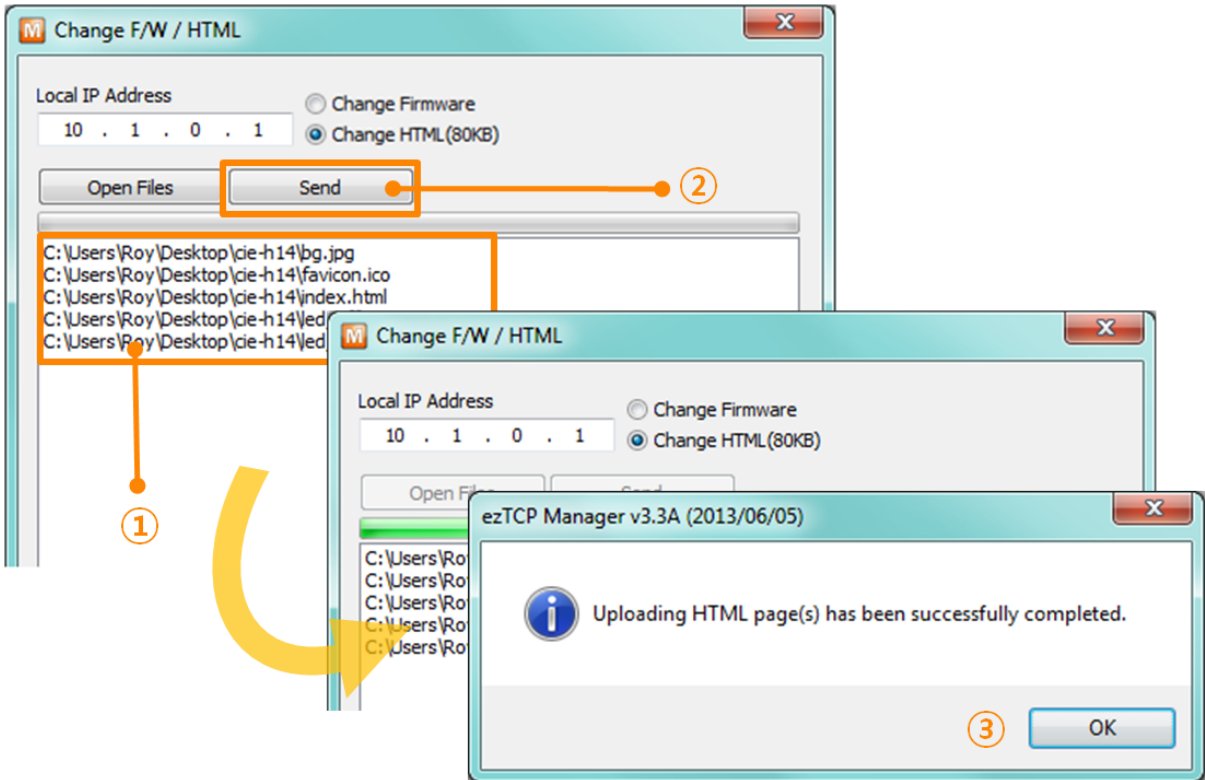

Figure 7-5 sending firmware file

- ① Check if the name and path of the files are correct
- ② Click the [Send] button
- ③ Confirm the completed message

## 7.3 Status Monitoring

### 7.3.1 Using TELNET

Once the [TELNET] option is activated, users can remotely log in to CIE-H10. If a password is set, users should input the password.

After that, messages from CIE-H10 appear as shown in the figure below.

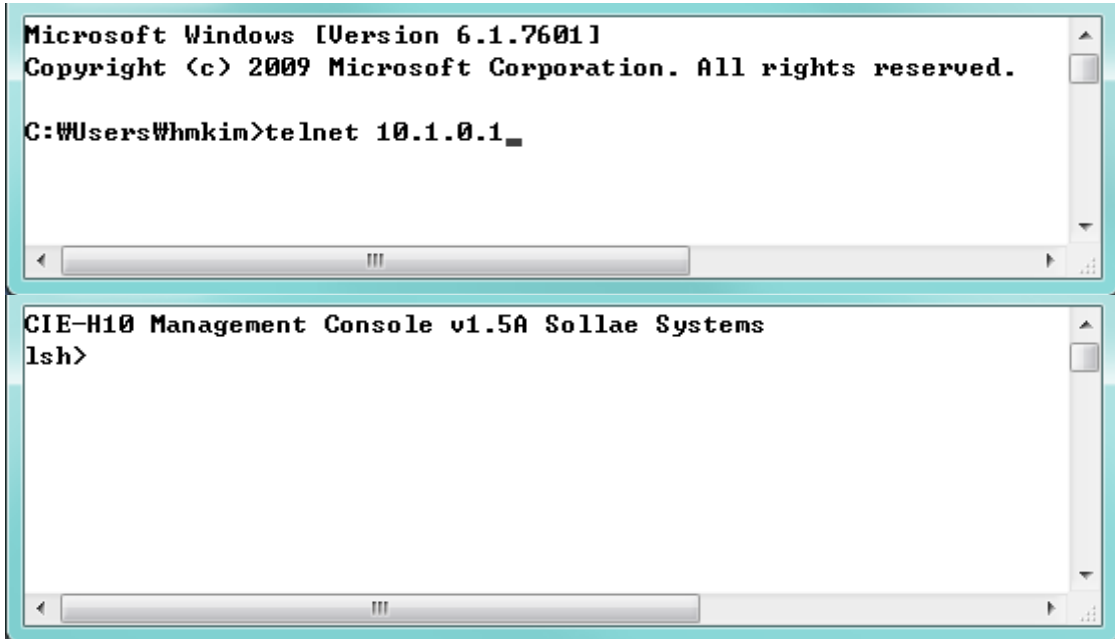

Figure 7-6 log in to CIE-H10 on TELNET

You can check multiple states with the following commands.

Command	option	description	usage
st	net	Network Status	lsh>st net
	sio	Serial Port Status	lsh>st sio
	uptime	System Uptime	lsh>st uptime
sc	[OP1][OP2]	Session Control	lsh>sc com1 close
sd	[OP1][OP2]	Capturing Serial Data	lsh>sd 1 100

Table 7-1 commands for checking states

- st net

"st net" command displays present network states of all sessions.

```
lsh>st net
```

proto	name	local address	peer address	sendq	state
TCP	tty	10.1.0.1< 23>	10.7.0.57<50962>	140	ESTABLISHED
TCP	http7	10.1.0.1< 80>	0.0.0.0< 0>	0	LISTEN
TCP	http6	10.1.0.1< 80>	0.0.0.0< 0>	0	LISTEN
TCP	http5	10.1.0.1< 80>	0.0.0.0< 0>	0	LISTEN
TCP	http4	10.1.0.1< 80>	0.0.0.0< 0>	0	LISTEN
TCP	http3	10.1.0.1< 80>	0.0.0.0< 0>	0	LISTEN
TCP	http2	10.1.0.1< 80>	0.0.0.0< 0>	0	LISTEN
TCP	http1	10.1.0.1< 80>	0.0.0.0< 0>	0	LISTEN
TCP	http0	10.1.0.1< 80>	0.0.0.0< 0>	0	LISTEN
TCP	nbus0	10.1.0.1< 502>	0.0.0.0< 0>	0	LISTEN
TCP	com1	0.0.0.0< 1470>	0.0.0.0< 0>	0	LISTEN

Figure 7-7 "st net" command

- st sio

"st sio" command displays the number of bytes for the serial port.

```
lsh>st sio
```

port	fmax	rbmax	rxbuf	txbuf	rx_count	tx_count
com1	0	0	0	0	0	56

Figure 7-8 "st sio" command

- st uptime

"st uptime" command shows amount of time since H10 has booted up.

```
lsh>st uptime
00:23:55.13 up 0 days
```

Figure 7-9 "st uptime" command

- sc

"sc" command is used when users close a session. [OP1] means the name of session, and [OP2] should be "CLOSE".

```
lsh>sc com1 close
com1: closed
```

Figure 7-10 "sc" command

☞ *Lower-case letters are only allowed to use "sc" command.*

- sd

"sd" command is for capturing serial data. [OP1] means name of the session, [OP2] means period, which has a 10ms unit, for the capture.

```
lsh>sd 1 100
com1 dump buffering time : 1000ms
lsh>tx1 => 73 6f 6c 6c 61 65 73 79 73 74 65 6d 73          | sollaes y stems
tx1 => 74 65 73 74                                         | test
```

Figure 7-11 "sd" command

### 7.3.2 Using ezManager

Status of CIE-H10 can be monitored by [Status] button on ezManager. By using the [Refresh Every 1 Second] option in the status window, the status is automatically updated in every second.

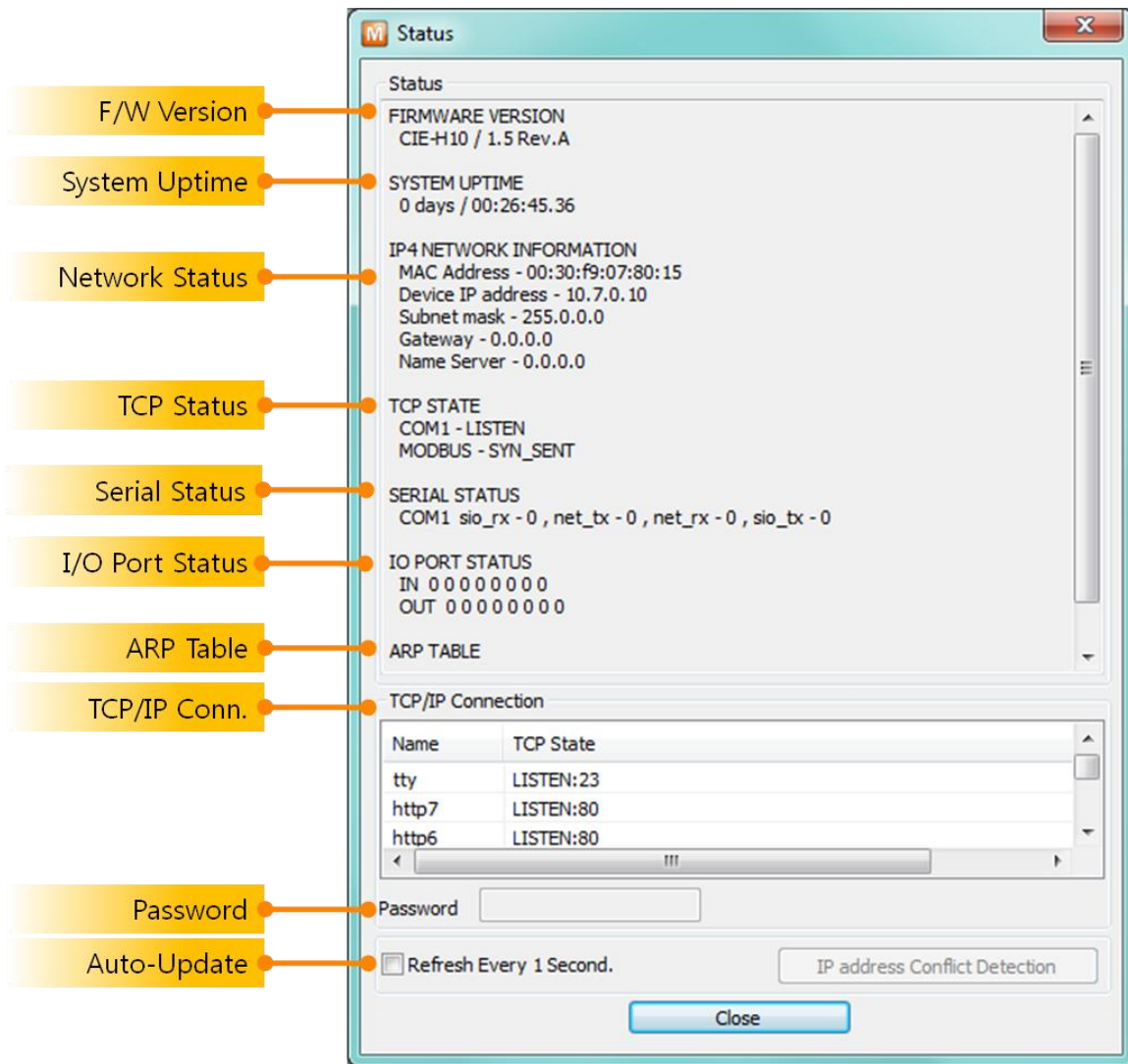

Figure 7-12 status window of ezManager

- **FIRMWARE VERSION**  
The name of model and the version of firmware are displayed here.
- **SYSTEM UPTIME**  
Operating time of CIE-H10 is displayed since it boots up.
- **IP4 NETWORK INFORMATION**  
All information about related items with IP Address including the MAC address is shown here. It works even if the IP address is assigned from DHCP or PPPoE.

- TCP STATE

TCP status of each port is shown in this section.

Message	Description
LISTEN	waiting for requests of a TCP connection
CLOSE	a TCP connection is closed
SYN_SENT	send "SYN" segment to make a TCP connection
ESTABLISHED	When a TCP connection is established
N/A	In UDP mode

Table 7-2 TCP STATE

- SERIAL STATUS

Amount of data in every buffer is displayed. The unit is byte.

Buffer	Description
sio_rx	The number of data which is received from the COM port
net_tx	The number of data which is sent to the remote host
net_rx	The number of data which is received from the remote host
sio_tx	The number of data which is sent to the COM port

Table 7-3 SERIAL STATUS

- I/O PORT STATUS

This represents I/O ports' status. '1' means HIGH(ON) and '0' means LOW(OFF).

- ARP TABLE

This part shows ARP table on CIE-H10. When a TCP connection is established or UDP data communication is performed, the information of IP and MAC address is automatically stored in the ARP table. This information is held for 1 minute. If there is no data communication for 1 minute, the information will be removed.

- TCP/IP Connection

In this section, the same information with TCP STATE is displayed with IP address and port number. A difference is that users can terminate a TCP connection. When right click on a session, a small pop-up window is created.

- Password

This text box is activated when CIE-H10 has a password. If users want to close the TCP connection, this password has to be correctly filled.

- Refresh Every 1 Second.

If this option is checked, ezManager sends query in every second.



## 8 Additional Functions

### 8.1 Security

#### 8.1.1 Restriction of Access (ezTCP Firewall)

On the [Option] tab of ezManager, users can set restriction of access function with filtering MAC and IP address.

- Allowed MAC Address  
If this option has a value of MAC address, the device which has the MAC address is only permitted to access.
- Allowed IP Address  
This is to define hosts with IP address or range of IP address allowed to access. The range is defined by multiplying [IP address] and [Network Mask] in bit unit.
- Examples

IP Address	Network Mask	Allowed IP Address Range
10.1.0.1	255.0.0.0	10.1.0.1 ~ 10.255.255.254
10.1.0.1	255.255.255.0	10.1.0.1 ~ 10.1.0.254
192.168.1.4	255.255.255.255	192.168.1.4

Table 8-1 examples of defining allowed IP range

- Apply to ezManager  
[Apply to ezManager] is for applying above two restrictions to ezManager functions like [Search], [Read], [Write], etc.

#### 8.1.2 Setting Password

A password can be used to protect CIE-H10 from TELNET login or changing environmental parameters by hosts who are not designated. The maximum length is 8 bytes of Alphabet or number.

☞ ***When you want to revoke all of these restrictions, change the mode of CIE-H10 to the ISP mode. All restrictions are removable and communication with ezManager is revoked in the ISP mode.***

## 8.2 Option Tab Functions

### 8.2.1 Notify IP Change

CIE-H10 can be a TCP server even though it is assigned the IP address automatically. Using [Notify IP Change] function, it sends its IP address with the host name to the specific server. There are 3 types of functions provided: DDNS, TCP and UDP.

- Dynamic Domain Name Service (DDNS)

CIE-H10 supports DDNS function offered by DynDNS to manage its changed IP address as a host name. Therefore, you have to make an account and create host names on the website of DynDNS before use this.

☞ *All about service usage of an account could be changed according to the policy of DynDNS.*

☞ *Homepage of DynDNS: <http://dyn.com/dns/>*

Figure 8-1 setting DDNS

- ① Select the [DDNS (dyndns.org)] item.
- ② 40,320 is a fixed value.
- ③ Input the ID of DDNS account.
- ④ Input the password of the account.
- ⑤ Input one of the host names which you created on your account.

- TCP/UDP

In case you have an own server and want to manage the information about changed IP addresses, you are allowed to use TCP/UDP for using this option. The [Data Type] can be selected as ASCII or hexadecimal, and the [Interval] is available on configuration.

☞ *Refer to the [Notify IP Change] on our web site for details.*

## 8.2.2 Sending MAC Address

[Sending MAC Address] is a function that CIE-H10 sends its MAC address to the remote host right after the connection is established. By using this function, a server can identify multiple devices with the information.

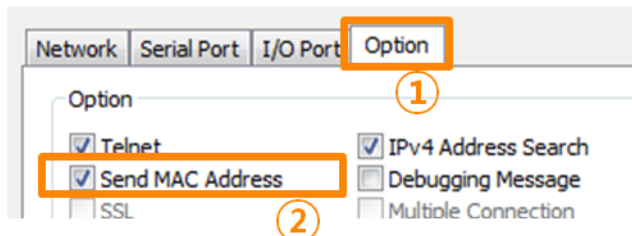

Figure 8-2 setting of Sending MAC Address function

- ① Move to the [Option] tab.
- ② Check the [Send MAC Address] option.

## 8.2.3 Debugging Message

By using [Debugging] option, users can receive debugging messages from CIE-H10 on the network.

- ☞ ***When you are facing a problem about the TCP connection or data communication, use this function and send us the stored file. We can use it for finding out the reason of your problem.***
- ☞ ***Debugging messages are broadcasted to entire network via UDP so it might cause serious network traffic. Remember you should turn the option off after using it.***

- Setting debugging option

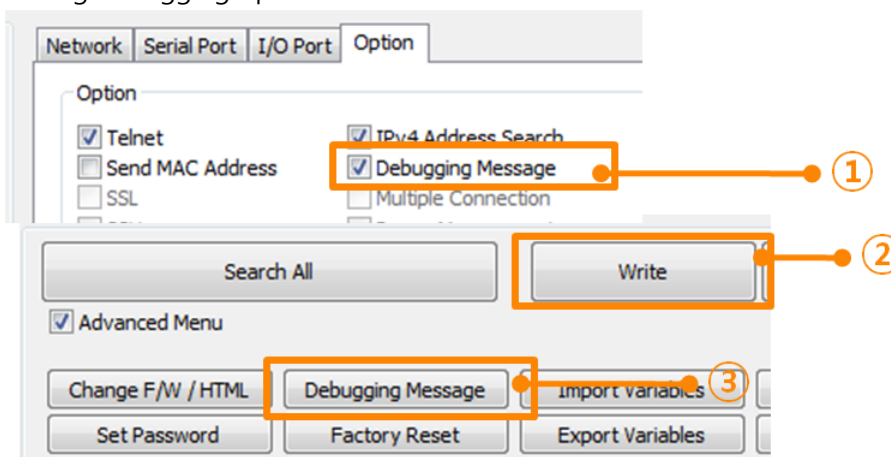

Figure 8-3 setting debugging option

- ① Check the [Debugging Message] option
- ② Press the [Write] button
- ③ After checking the [Advanced Menu], click the [Debugging Message] button. And

then, the debugging message window appears on your screen as shown below.

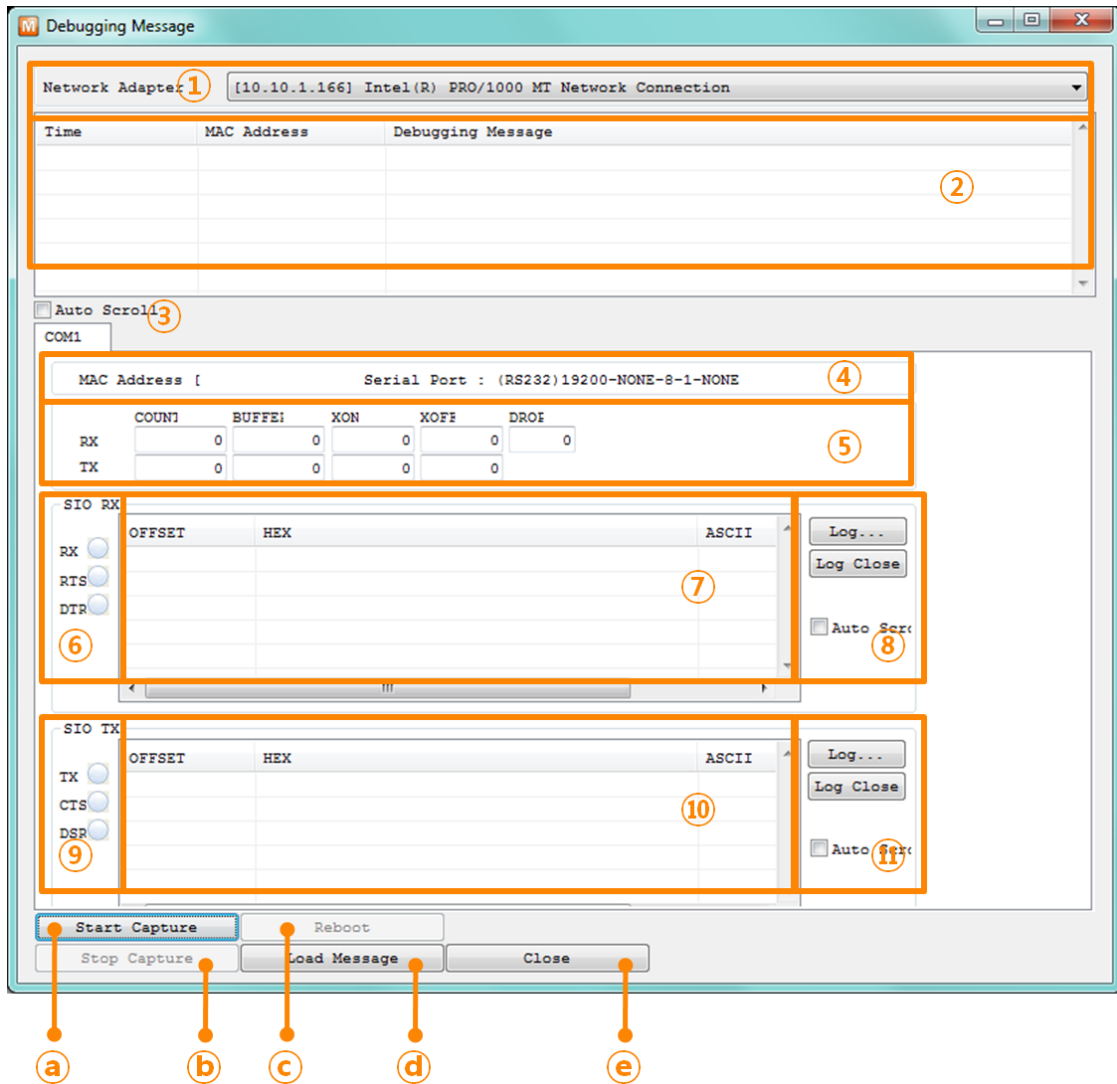

Figure 8-4 debugging message window

- ① Pull down menu for selecting a network adapter
- ② Place for showing received debugging messages from CIE-H10 over the network
- ③ Auto update to display the latest captured file on the screen of ②
- ④ MAC Address Information of a selected message
- ⑤ ~ ⑪ Unavailable
- a) To start capturing debugging messages from CIE-H10
- b) To stop capturing debugging messages from CIE-H10
- c) Unavailable
- d) [Load Message] is for loading a debugging log file to display
- e) Closing debugging message window

## 8.3 Serial Port Tab Functions

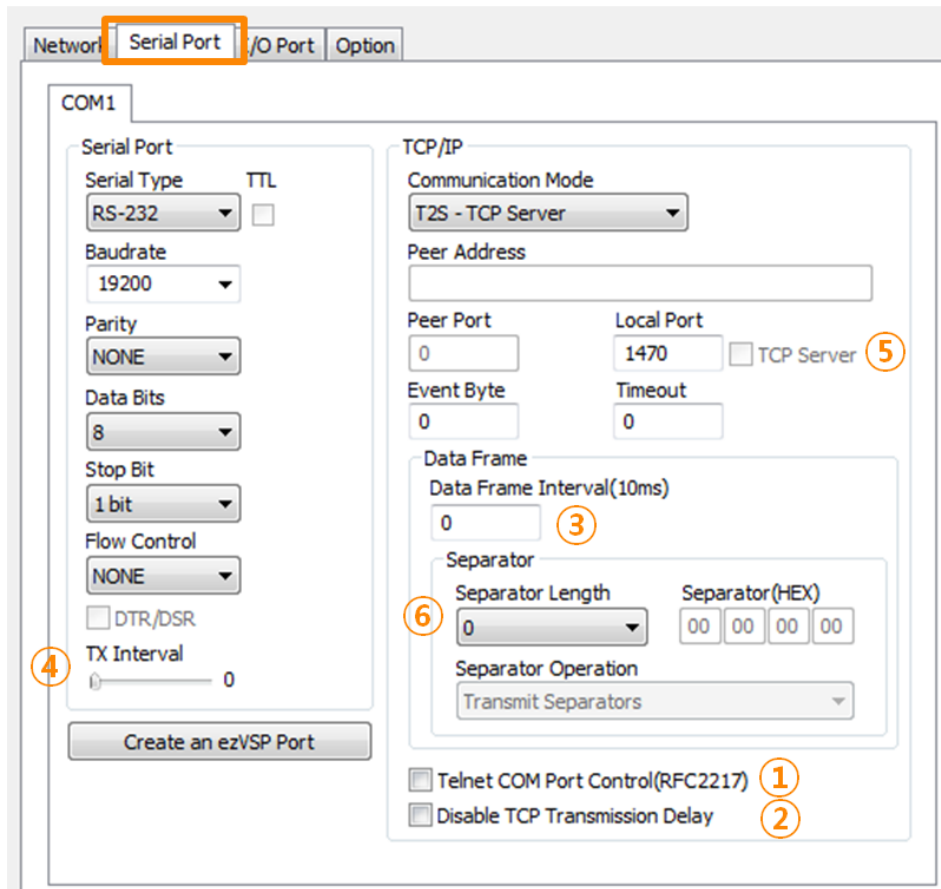

Figure 8-5 Serial Port Tab

### 8.3.1 TELNET COM port Control Option (RFC 2217) - ①

This option is for sending and receiving serial port states between two devices. Users can send and receive control signals such as RTS/CTS when the states are changed.

### 8.3.2 Disable TCP Transmission Delay - ②

If you use this option, CIE-H10 sends the data from the serial port to Ethernet as quickly as possible.

### 8.3.3 Data Frame Interval - ③

Before sending data from the serial port to Ethernet, ezTCP gathers data in the buffer. If there is no data during the specific time configured in the [Data Frame Interval], ezTCP will send data to the network. In case the value is set to 0, data will be sent immediately.

*Please set this value to 11 or higher values for correct operation.*

### 8.3.4 TX interval - ④

This option is for preventing data loss in the case that the serial device has very small buffer size or does not have a buffer. The range of the value could be from 0 to 25 and the unit is duration of sending 1 byte. For example, if you set this value to 5, each byte will be transferred with duration of sending 5 bytes.

### 8.3.5 TCP Server / Client mode - ⑤

This mode is available on TCP client mode only. In this mode, you do not need to change the mode for switching active or passive TCP connection. Note that the [Event Byte] option should be set to 1 or larger value.

### 8.3.6 Separator - ⑥

Using this function, you can control the length of network packets by specific characters.

Separator	options
Length	select the length between 0 ~ 4 bytes
Operation	Transmit Separators without additional bytes
	Transmit Separators + 1 byte
	Transmit Separators + 2 bytes

Table 8-2 separator

 ***If you want to get more information about the above functions, refer to the technical documents on the [Download] >> [Technical documents] page at our web site.***

## 8.4 Digital I/O Functions

### 8.4.1 Valid Time

CIE-H10 only recognizes signals of the input ports as the valid signals when the signal lasts for the [Valid Time]. If the signals are not maintained for the [Valid Time], the input signals will be ignored. The unit used for the [Valid Time] is 1ms. However, because the accuracy is only guaranteed in 10ms, the designated values are rounded down in units of 10ms.

### 8.4.2 Delay

Output values are reflected to CIE-H10's output ports later than the time set to [Delay]. For example, if [Delay] is set to '0', the output values are reflected to the output ports immediately. Although it is allowed to set the values in 1ms, it is accurate to 10ms, rounded down.)

☞ ***If the timer for the [Delay] is already running, all the subsequent orders for giving signals to the output ports are ignored.***

## 9 Self-Test in Trouble

When users are in trouble with using CIE-H10, make sure of the following steps first.

### 9.1 Searching problem with ezManager

- Confirming types of configuration utility  
CIE-H10 can be configured by ezManager.
- Cancelling the Firewall operation  
In case of being blocked by firewalls of a personal computer or network block, you must cancel all the firewalls before searching CIE-H10.

☞ ***Most of vaccine programs have firewall functions so it can cause some trouble to search CIE-H10. Close or pause these programs before searching the product.***

- Stable supply of the power  
Check if the power is supplied continually. The red LED on CIE-H10 shows that the power is switched on.
- Connection with the network  
Make sure that the network connection is fine including Ethernet cable. In this step, we recommend that users connect CIE-H10 with PC directly or in the same network hub.
- Checking options of restriction  
In case that restriction of access is activated, the communication with ezManager will be unavailable. When users are in this situation, make CIE-H10 operate in ISP mode.



## 9.2 Connection Problem over Modbus/TCP

- Checking parameters related with TCP/IP

When CIE-H10 has a private network IP address, personal computer's IP address has to be on the same sub network. Check if the IP address and local port number are correct. In case of a fixed IP address, the subnet mask, gateway IP address and DNS IP address should be configured.

Slave or Master
Local IP Address, the connection mode (Active / Passive), Peer Address and Peer Port, Subnet Mask, Gateway IP Address, DNS IP Address, DDNS option and etc.

Table 9-1 major parameters related with Modbus/TCP

- PING Test

Confirm the connection over the network by PING test. If CIE-H10 does not send any reply from the request, check the network environment.

- Firewall

In case the networks which need strong security, the access may be denied by their firewall. Under this circumstance, users should ask the person in charge of their network to release ports which will be used. (Ex: TCP 502, UDP 50005)

- Operation Mode

A TCP connection is not possible when CIE-H10 is operating in the ISP or Serial Configuration mode.

- Connection Mode

To make a TCP connection, both a server (passive mode) and a client (active mode) should exist. If there are only servers or clients, the TCP connection cannot be established.

- ezTCP Firewall

When users set the ezTCP firewall with MAC and IP address, any hosts cannot be reachable to it except for the hosts who have the allowed MAC and IP address. Inactivate the option or check the setting is correct.

- Checking the TCP status

TCP is a protocol connected one to one without multiple connections function. Because of this, if a device is on a TCP connection, other requests are denied. If users are in this situation, check the network status by connecting on TELNET or using ezManager.

### 9.3 Communication Problem over Modbus/TCP

- Checking Modbus/TCP parameters

Check all the related parameters that [Unit ID], [Input Port Base Address], [Output Port Base Address], [Poll Interval] and [Notify Input change].

- Checking which mode is using

In case of MACRO or serialized Modbus/TCP, you can control the outputs of CIE-H10. Turn the mode off if those modes are using.

☞ *Contact us if you have any questions about above steps or our products.*

## 10 Related material

### 10.1 Technical Documents

You can find the following technical documents at our website.

- Datasheet
- Modbus/TCP protocol
- Internet switch
- Serial switch
- Combinations of I/O Controllers
- Digital Pulse Output
- Dry Contact Adapter (DCA)
- IP Change Notification (DDNS)
- Sending MAC Address function
- TCP Server/Client mode
- Telnet COM Port Control Option
- Modmap Users' manual
- etc

### 10.2 Smart phone application

- ezManager (iOS)
- ezManager (Android)
- TCP/IP Client (Android)

# 11 Technical Support and Warranty

## 11.1 Technical Support

If you have any question regarding operation of the product, visit Customer Support FAQ corner and the message board on Sollae Systems' web site or send us an email at the following address:

- E-mail: [support@eztcp.com](mailto:support@eztcp.com)
- Website Address for Customer Support: <http://www.eztcp.com/en/support/>

## 11.2 Warranty

### 11.2.1 Refund

Upon the customer's request to refund the product within two weeks after purchase, Sollae Systems will refund the product.

### 11.2.2 Free Repair Services

For product failures occurring within 2 years after purchase, Sollae Systems provides free repair services or exchange the product. However, if the product failure is due to user's fault, repair service fees will be charged or the product will be replaced at user's expense.

### 11.2.3 Charged Repair Services

For product failures occurring after the warranty period (2 years) or resulting from user's fault, repair service fees will be charged and the product will be replaced at user's expense.

## 12 Precaution and Exemption from Liability

### 12.1 Precaution

- Sollae Systems is not responsible for product failures occurring due to user's alteration of the product.
- Specifications of the product are subject to change without prior notice for performance improvement.
- Sollae Systems does not guarantee successful operation of the product if the product was used under conditions deviating from the product specifications.
- Reverse engineering of firmware and applications provided by Sollae Systems is prohibited.
- Use of firmware and applications provided by Sollae Systems for purposes other than those for which they were designed is prohibited.
- Do not use the product in an extremely cold or hot place or in a place where vibration is severe.
- Do not use the product in an environment in which humidity is high or a lot of oil exists.
- Do not use the product where there is caustic or combustible gas.
- Sollae Systems does not guarantee normal operation of the product under the conditions a lot of noise exists.
- Do not use the product for a purpose that requires exceptional quality and reliability relating to user's injuries or accidents – aerospace, aviation, health care, nuclear power, transportation, and safety purposes.
- Sollae Systems is not responsible for any accident or damage occurring while using the product.

## 12.2 Exemption from Liability

### 12.2.1 English version

In no event shall Sollae Systems Co., Ltd. And its distributors be liable for any damages whatsoever (including, without limitation, damages for loss of profit, operating cost for commercial interruption, loss of information, or any other financial loss) from the use or inability to use the CIE-H10 even if Sollae Systems Co., Ltd. Or its distributors have been informed of such damages.

The CIE-H10 is not designed and not authorized for use in military applications, in nuclear applications, in airport applications or for use in applications involving explosives, or in medical applications, or for use in security alarm, or for use in a fire alarm, or in applications involving elevators, or in embedded applications in vehicles such as but not limited to cars, planes, trucks, boats, aircraft, helicopters, etc..

In the same way, the CIE-H10 is not designed, or intended, or authorized to test, develop, or be built into applications where failure could create a dangerous situation that may result in financial losses, damage to property, personal injury, or the death of people or animals. If you use the CIE-H10 voluntarily or involuntarily for such unauthorized applications, you agree to subtract Sollae Systems Co., Ltd. And its distributors from all liability for any claim for compensation.

Sollae Systems Co., Ltd. And its distributors entire liability and your exclusive remedy shall be Sollae Systems Co., Ltd. And its distributors option for the return of the price paid for, or repair, or replacement of the CIE-H10.

Sollae Systems Co., Ltd. And its distributors disclaim all other warranties, either expressed or implied, including, but not limited to, the implied warranties of merchantability and fitness for a particular purpose, with respect to the CIE-H10 including accompanying written material, hardware and firmware.

### 12.2.2 French version

- Documentation

La documentation du boîtier CIE-H10 est conçue avec la plus grande attention. Tous les efforts ont été mis en œuvre pour éviter les anomalies. Toutefois, nous ne pouvons garantir que cette documentation soit à 100% exempt de toute erreur. Les informations présentes dans cette documentation sont données à titre indicatif. Les caractéristiques techniques

peuvent changer à tout moment sans aucun préavis dans le but d'améliorer la qualité et les possibilités des produits.

- Copyright et appellations commerciales

Toutes les marques, les procédés, les références et les appellations commerciales des produits cités dans la documentation appartiennent à leur propriétaire et Fabricant respectif.

- Conditions d'utilisations et limite de responsabilité

En aucun cas Sollae Systems Co., Ltd. ou un de ses distributeurs ne pourra être tenu responsable de dommages quels qu'ils soient (intégrant, mais sans limitation, les dommages pour perte de bénéfice commercial, interruption d'exploitation commerciale, perte d'informations et de données à caractère commercial ou de toute autre perte financière) provenant de l'utilisation ou de l'incapacité à pouvoir utiliser le boîtier CIE-H12, même si Sollae Systems Co., Ltd. ou un de ses distributeurs a été informé de la possibilité de tels dommages.

Le boîtier CIE-H10 est exclusivement prévu pour un usage en intérieur, dans un environnement sec, tempéré (+10 °C à +40°C) et non poussiéreux. Le boîtier CIE-H10 n'est pas prévu, ni autorisé pour être utilisé en extérieur, ni de façon embarquée dans des engins mobiles de quelque nature que ce soit (voiture, camion, train, avion, etc...), ni en milieu explosif, ni dans des enceintes nucléaires, ni dans des ascenseurs, ni dans des aéroports, ni dans des enceintes hospitaliers, ni pour des applications à caractère médical, ni dans des dispositifs de détection et d'alerte anti-intrusion, ni dans des dispositifs de détection et d'alerte anti-incendie, ni dans des dispositifs d'alarme GTC, ni pour des applications militaires.

De même, le boîtier CIE-H10 n'est pas conçu, ni destiné, ni autorisé pour expérimenter, développer ou être intégré au sein d'applications dans lesquelles une défaillance de celui-ci pourrait créer une situation dangereuse pouvant entraîner des pertes financières, des dégâts matériel, des blessures corporelles ou la mort de personnes ou d'animaux. Si vous utilisez le boîtier CIE-H10 volontairement ou involontairement pour de telles applications non autorisées, vous vous engagez à soustraire Sollae Systems Co., Ltd. et ses distributeurs de toute responsabilité et de toute demande de dédommagement.

En cas de litige, l'entière responsabilité de Sollae Systems Co., Ltd. et de ses distributeurs vis-à-vis de votre recours durant la période de garantie se limitera exclusivement selon le choix de Sollae Systems Co., Ltd. et de ses distributeurs au remboursement de votre

produit ou de sa réparation ou de son échange. Sollae Systems Co., Ltd. et ses distributeurs démentent toutes autres garanties, exprimées ou implicites.

Tous les boîtiers CIE-H10 sont testés avant expédition. Toute utilisation en dehors des spécifications et limites indiquées dans cette documentation ainsi que les court-circuit, les chocs, les utilisations non autorisées, pourront affecter la fiabilité, créer des dysfonctionnements et/ou la destruction du boîtier CIE-H10 sans que la responsabilité de Sollae Systems Co., Ltd. et de ses distributeurs ne puissent être mise en cause, ni que le boîtier CIE-H10 puisse être échangé au titre de la garantie.

- Rappel sur l'évacuation des équipements électroniques usagés

Le symbole de la poubelle barré présent sur le boîtier CIE-H10 indique que vous ne pouvez pas vous débarrasser de ce dernier de la même façon que vos déchets courants. Au contraire, vous êtes responsable de l'évacuation du boîtier CIE-H10 lorsqu'il arrive en fin de vie (ou qu'il est hors d'usage) et à cet effet, vous êtes tenu de le remettre à un point de collecte agréé pour le recyclage des équipements électriques et électroniques usagés. Le tri, l'évacuation et le recyclage séparés de vos équipements usagés permettent de préserver les ressources naturelles et de s'assurer que ces équipements sont recyclés dans le respect de la santé humaine et de l'environnement. Pour plus d'informations sur les lieux de collecte des équipements électroniques usagés, contacter votre mairie ou votre service local de traitement des déchets.



## 13 History

Date	Version	Comment	Author
2007.03.22	0.5	○ Initial touch	
2007.06.11	1.0	○ Initial Release	
2007.06.28	1.1	○ Add Security Function	
2007.06.29	1.2	○ Correct Maximum Input Port Voltage	
2007.07.16	1.3	○ Change English Expressions by JJS	
2007.09.03	1.4	○ Add Telnet COM Port Control Option	
2007.09.19	1.5	○ Add DDNS(Dynamic DNS)	
2008.01.10	1.6	○ Modify Digital Input Interface's Drawing	
2008.05.28	1.7	○ Change Images, Modify ATC description ○ Add IP Change Trap, HTTP Port Number	
2008.08.06	1.8	○ Serial Parity – MARK/SPACE add	
2009.06.18	2.0	○ Add description of Serialized Modbus/TCP ○ Add description of Users Web Page ○ Add contents of new ezManager ○ Add the description of serial configuration mode ○ Add the description of U2S echo function ○ Modify the table of System LED ○ Modify most of the figures ○ Change the form of document ○ Change the home page link of Technical support ○ Reduce the contents about ezManager ○ Remove the ATC chapter ○ Correct some expressions	
2009.12.02	2.1	○ The style of document has been changed. ○ Application Diagrams have been added. ○ Operating / Storage temperature have been added. ○ The form of history has been modified. ○ Most of figures have been updated. ○ Description of "sc" command has been modified. ○ Maximum value of Event byte has been added. ○ Description of "Sending MAC Address and RFC2217 option have been modified.	Roy LEE
2009.12.14	2.2	○ The table 4-1 has been changed.	Roy LEE

2010.08.30	2.3	<ul style="list-style-type: none"> <li>○ The description of the CIE-H10 has been changed.</li> <li>○ Major icons have been inserted on the front cover.</li> </ul>	Roy LEE
2011.01.20	2.4	<ul style="list-style-type: none"> <li>○ Descriptions about input/output ports have been added.</li> <li>○ Diagram of "Macro mode" has been added.</li> <li>○ The name of caption for figures is changed.</li> </ul>	Roy LEE
2011.08.01	2.5	<ul style="list-style-type: none"> <li>○ Some expressions have been corrected or modified.</li> <li>○ A caution has been added about using MACRO.</li> <li>○ A figure of location of the ISP switch has been added.</li> <li>○ Pictures of the configuration tool have been updated.</li> <li>○ A picture of the default web server has been updated.</li> <li>○ Descriptions about the new functions have been added.</li> </ul> <p>(FC 05, Multiple connections, write pulse and etc.)</p> <ul style="list-style-type: none"> <li>○ Chapter 8 has been reconstructed.</li> <li>○ The link for the support page has been corrected.</li> </ul>	Roy LEE
2011.08.09	2.6	<ul style="list-style-type: none"> <li>○ Maximum value of Event Byte has been corrected.</li> <li>○ Figure 4-1 has been changed.</li> <li>○ Descriptions of TCP Server/Client mode has been modified</li> </ul>	Roy LEE
2011.12.14	2.7	<ul style="list-style-type: none"> <li>○ Descriptions of DynDNS service has been changed.</li> <li>○ Descriptions of FIFO function has been deleted.</li> </ul>	Amy Kim
2012.02.08	2.8	<ul style="list-style-type: none"> <li>○ Add recommended values of the Event Byte</li> <li>○ Download link and Typo have been fixed.</li> </ul>	Amy Kim
2012.05.23	2.9	<ul style="list-style-type: none"> <li>○ A picture of the default web server has been updated.</li> <li>○ Extend the warranty period to two years</li> </ul>	Amy Kim
2012.06.25	3.0	<ul style="list-style-type: none"> <li>○ Change description of network interface</li> <li>○ Remove description about PPPoE and DHCP</li> </ul>	Amy Kim
2013.02.07	3.1	<ul style="list-style-type: none"> <li>○ Change voltage conditions of output port</li> </ul>	Todd Song
2013.05.09	3.2	<ul style="list-style-type: none"> <li>○ Add related material</li> <li>○ Add Exemption From Liability</li> </ul>	Amy Kim
2013.05.16	3.3	<ul style="list-style-type: none"> <li>○ Add Exemption From Liability (French version)</li> <li>○ Add Features</li> </ul>	Amy Kim
2013.08.21	3.4	<ul style="list-style-type: none"> <li>○ Add the function of Pulse Control through WEB</li> <li>○ Modify the screen capture images to new version.</li> </ul>	Amy Kim
2013.12.26	3.5	<ul style="list-style-type: none"> <li>○ Correct some errors and expressions</li> </ul>	Amy Kim